

QRAE 3™

Wireless Personal Four-Gas Monitors



Product Registration

Register your product online by visiting:

<http://www.raesystems.com/support/product-registration>

By registering your product, you can:

- Receive notification of product upgrades or enhancements
- Be alerted to Training classes in your area
- Take advantage of RAE Systems special offers and promotions

QRAE 3 User's Guide

Contents

1. Standard Contents	5
2. General Information.....	6
3. User Interface.....	7
3.1. Display Overview.....	7
3.1.1. Status Indicator Icons.....	7
3.1.2. LCD Flip.....	8
3.1.3. Keys & Interface.....	8
3.2. Screen Display For Various Numbers Of Active Sensors	9
3.3. Menus.....	9
4. Wireless Control And Submenus.....	9
5. Battery.....	10
6. Turning The QRAE 3 On And Off	12
7. Modes Of Operation	14
8. Programming.....	15
8.1. Enter Programming In Basic Mode.....	15
8.2. Enter Programming In Advanced Mode	17
8.3. Menus And Submenus	18
8.3.1. Editing And Selecting Parameters And Sensors.....	18
8.3.2. Calibration.....	19
8.3.3. Measurement.....	21
8.3.4. Datalog.....	24
8.3.5. Monitor.....	25
8.3.6. Wireless.....	27
9. Policy Enforcement.....	30
10. Calibration And Testing.....	33
10.1. Manual Alarms Test	33
10.2. Bump Testing And Calibration.....	33
10.2.1. Bump (Functional) Testing.....	34
10.3. Zero Calibration.....	35
10.3.1. Zero Calibration	35
10.3.2. Single-Sensor Zero Calibration.....	35
10.4. Span Calibration	35
10.4.1. QRAE 3 Pumped Model	35
10.4.2. QRAE 3 Diffusion Model.....	36
10.4.3 Multi-Sensor Span Calibration	37
10.4.4. Single-Sensor Span Calibration	37
11. Datalog Transfer, Monitor Configuration, and Firmware Upgrades Via Computer ..	38
12. Maintenance.....	39
13. Alarms Overview	46
14. Troubleshooting	50
15. Diagnostic Mode.....	50
16. Specifications.....	52
17. Controlled Part of the Manual for PGM-25XX/D	56
18. Technical Support	67
19. RAE Systems Contacts	67

QRAE 3 User's Guide



This Manual must be carefully read by all individuals who have or will have the responsibility of using, maintaining, or servicing this product. The product will perform as designed only if it is used, maintained, and serviced in accordance with the manufacturer's instructions. The user should understand how to set the correct parameters and interpret the obtained results.

CAUTION!

- Only use RAE Systems battery pack P/N G02-3004-000 (Li-ion, rechargeable)
- Charge the instrument Li-ion battery using the appropriate RAE Systems charger and only outside hazardous areas
- Use of non-RAE Systems components will void the warranty and can compromise the safe performance of this product
- Warning: Substitution of components may impair intrinsic safety

SPECIAL CONDITIONS FOR SAFE USE

- The PGM-25XX/D multi-gas monitor must be calibrated if it does not pass a bump test, when a new sensor has been installed, or at least once every 180 days, depending on use and sensor exposure to poisons and contaminants
- No precautions against electrostatic discharge are necessary for portable equipment that has an enclosure made of plastic, metal or a combination of the two, except where a significant static-generating mechanism has been identified. Activities such as placing the item on a belt, operating a keypad or cleaning with a damp cloth, do not present a significant electrostatic risk. However, where a static-generating mechanism is identified, such as repeated brushing against clothing, then suitable precautions shall be taken, e.g., the use of anti-static footwear.

Note: Users are recommended to refer to ISA -RP12.13, Part II-1987 for general information on installation, operation, and maintenance of combustible gas detection instruments.

WARNINGS

ONLY THE COMBUSTIBLE GAS DETECTION PORTION OF THIS INSTRUMENT HAS BEEN ASSESSED FOR PERFORMANCE.

UNIQUEMENT, LA PORTION POUR DÉTECTOR LES GAZ COMBUSTIBLES DE CET INSTRUMENT A ÉTÉ ÉVALUÉE.

QRAE 3 User's Guide

CAUTION: BEFORE EACH DAY'S USAGE, SENSITIVITY OF THE COMBUSTIBLE GAS SENSOR MUST BE TESTED ON A KNOWN CONCENTRATION OF METHANE GAS EQUIVALENT TO 20 TO 50% OF FULL-SCALE CONCENTRATION. ACCURACY MUST BE WITHIN 0 AND +20% OF ACTUAL. ACCURACY MAY BE CORRECTED BY CALIBRATION PROCEDURE.

ATTENTION: AVANT CHAQUE UTILISATION JOURNALIERE VERIFIER LA SENSIBILITE AVEC UNE CONCENTRATION CONNUE DE METHANE EQUIVALENTE A 20-50% DE LA PLEINE ECHELLE. LA PRECISION DOIT ETRE COMPRISE ENTRE 0-20% DE LA VALEUR VRAIE ET PEUT ETRE CORRIGEE PAR UNE PROCEDURE D'ETALONNAGE.

CAUTION: HIGH OFF-SCALE READINGS MAY INDICATE AN EXPLOSIVE CONCENTRATION.

ATTENTION: DES LECTURES SUPERIEURES A L'ECHELLE PEUVENT INDIQUER DES CONCENTRATIONS EXPLOSIVES.

FCC Part 15 Statement

This device complies with Part 15 of the FCC rules. Operation is subject to the following two conditions: (1) This device may not cause harmful interference, and (2) this device must accept any interference received, including interference that may cause undesired operation.

QRAE 3 User's Guide

Product Marking

The QRAE 3 (PGM-25XX/D) is certified by IECEx, ATEX and CSA for US and Canada as intrinsically safe.

The PGM-25XX/D contains the following marking:

RAE SYSTEMS



3775 N. 1st. St., San Jose

CA 95134, USA

PGM-25XX/D

Type PGM-25XX/ PGM-25XXD

Serial No/barcode: XXXX-XXXX-XX

IECEX CSA 13.0029X Ex ia IIC T4 Ga	 0575  II 1G SIRA 13 ATEX 2390X Ex ia IIC T4 Ga	 12.2583152 Cl.I, Div 1, Grps A, B, C, D T4 Class I, Zone 0 AEX/Ex ia IIC T4 C22.2 No.152-M1984 ANSI/ISA-12.13.01-2000 Intrinsically safe/ Securite Intrinseque/Exia
---------------------------------------	---	--

Ambient temperature: $-20^{\circ}\text{C} \leq T_{\text{amb}} \leq +50^{\circ}\text{C}$

Um: 20V

Battery Packs: G02-3004-000 (Li-ion rechargeable)

Warning:

- Read User's Manual for intrinsic safety precautions
- Read and understand Manual before operating

QRAE 3 User's Guide

Proper Product Disposal At End Of Life



The Waste Electrical and Electronic Equipment (WEEE) directive (2002/96/EC) is intended to promote recycling of electrical and electronic equipment and their components at end of life. This symbol (crossed-out wheeled bin) indicates separate collection of waste electrical and electronic equipment in the EU countries. This product may contain one or more Nickel-metal hydride (NiMH), Lithium-ion, or Alkaline batteries. Specific battery information is given in this user guide. Batteries must be recycled or disposed of properly.

At the end of its life, this product must undergo separate collection and recycling from general or household waste. Please use the return and collection system available in your country for the disposal of this product.

Sensor Specifications, Cross-Sensitivities, And Calibration Information

For information on sensor specifications, cross-sensitivities, and calibration information, refer to RAE Systems Technical Note TN-114: Sensor Specifications And Cross-Sensitivities (available for free download from www.raesystems.com). All specifications presented in this Technical Note reflect the performance of standalone sensors. Actual sensor characteristics may differ when the sensor is installed in different instruments. As sensor performance may change over time, specifications provided are for brand-new sensors.

Make Sure Firmware Is Up To Date

For best operation, make sure your monitor is running the latest firmware. Check www.raesystems.com for updates.

QRAE 3 User's Guide

1. Standard Contents

The QRAE 3 is available in various user-specified configurations, each with the accessories shown below.

In addition to the instrument, the following are included:

Item	Part Number
Travel charger	M02-3005-000
Travel charger for barrier charger (for ATEX/IECEX version)	M02-3026-000
Barrier charger (for ATEX/IECEX version)	M02-3011-000
AC adapter	500-0036-102
External filter, 3 in package (pumped models)	008-3022-003
PC cable	410-0203-000
QRAE 3 CD	M02-4008-000
Software CD (ProRAE Studio II)	000-5007-001
QuickStart guide	M02-4002-000
T calibration tube for pumped models	M02-3008-000
Calibration cap for diffusion models	M02-3009-000
Calibration tube for diffusion models	M02-3010-000
Warranty card	000-4008-001
Calibration and test certificate card	700-0167-000

QRAE 3 User's Guide

2. General Information

The QRAE 3 is a family of multi-threat gas detectors that combines continuous monitoring capabilities for toxic and combustible gases with Man Down Alarm functionality in one highly portable instrument. QRAE 3 monitors are available in pumped and diffusion versions and offer a selection of field-replaceable electrochemical and combustible sensors to fit a wide variety of applications. The QRAE 3's wireless capability elevates worker protection to the next level by providing safety officers real-time access to instrument readings and alarm status from any location for better visibility and faster response.

2.1. Key Features

- All-in-one continuous monitoring capabilities for oxygen, toxic and combustible gases, for a total of up to four threats at a time
- Wireless access to real-time instrument readings and alarm status from any location
- Unmistakable five-way local and remote wireless notification of alarm conditions, including Man Down Alarm
- Large graphical display with easy-to-use, icon-driven user interface
- Simple maintenance with easily accessible sensors and pump

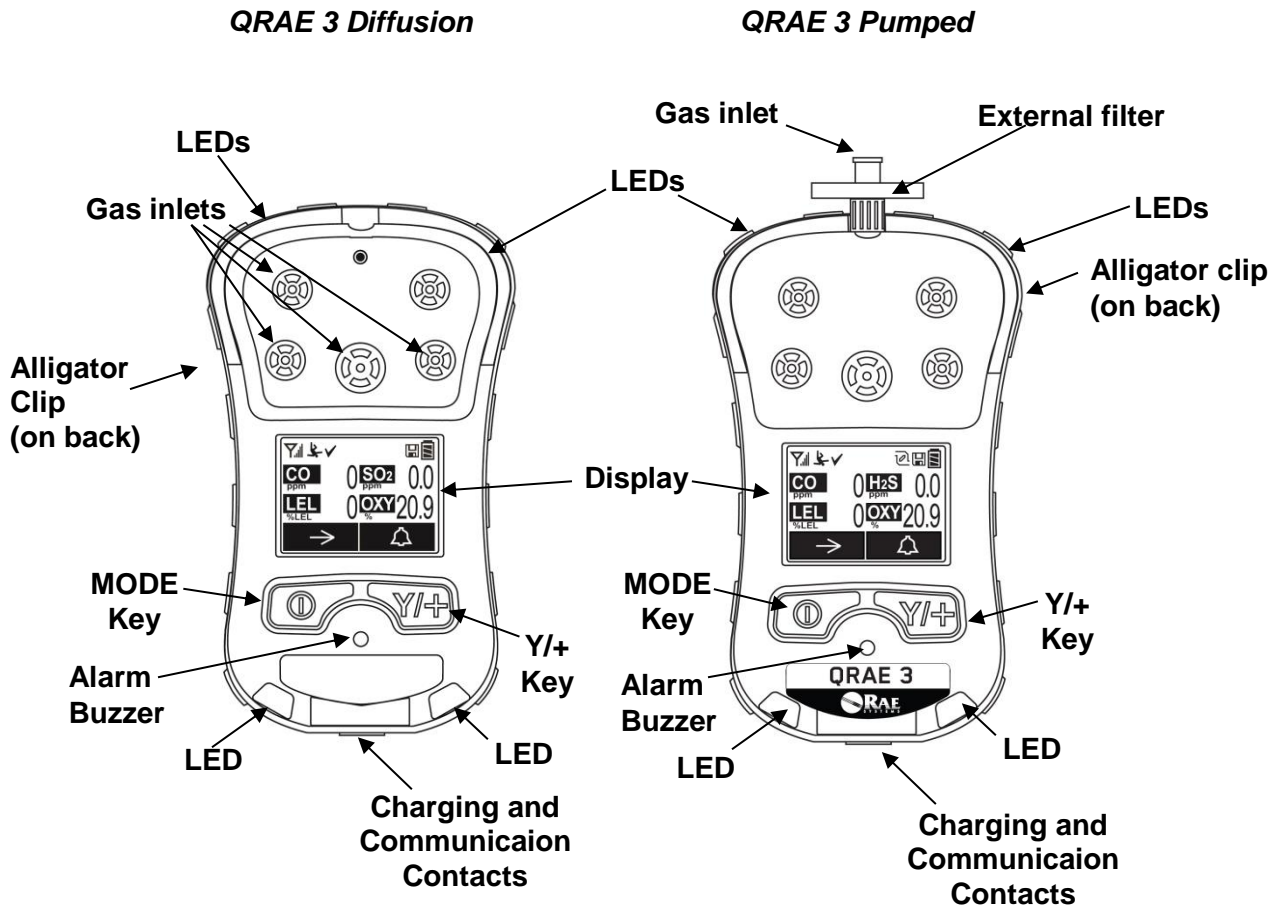

QRAE 3 User's Guide

3. User Interface

The QRAE 3's user interface consists of the display, LEDs, an alarm buzzer, and two keys.

3.1. Display Overview

The LCD display provides visual feedback that includes the sensor types, readings, battery condition, and other functions.

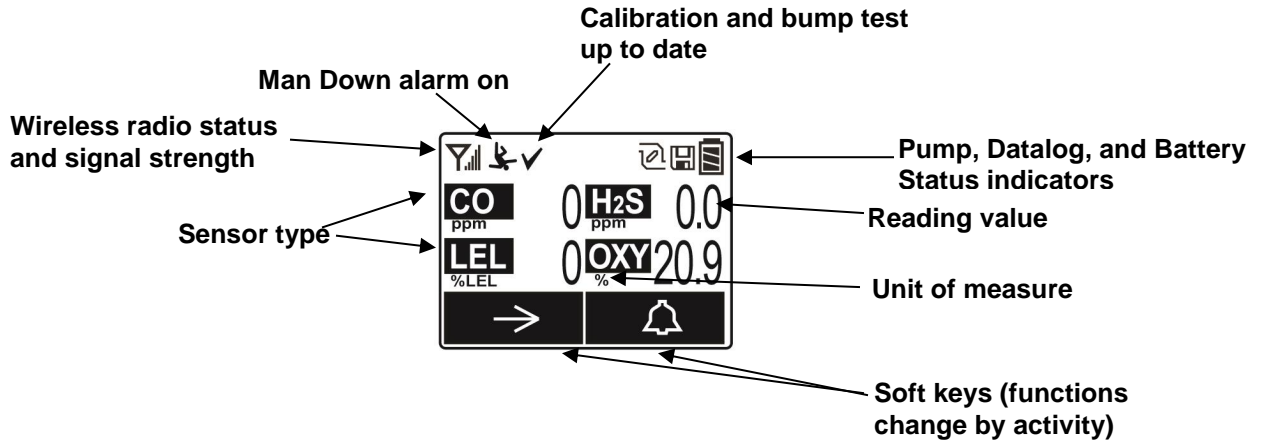

3.1.1. Status Indicator Icons

Along the top of most screens are status indicators that tell you whether a function is operating and/or its strength or level.

Icon	Function
	Wireless status: the radio is on (replaced by "R" when Roaming is on)
	Wireless status: the radio is off (replaced by "R" when Roaming is on)
	Roaming status: "R" blinks when trying to find a network (replaced by antenna when Roaming is off)
	Roaming status: "R" solid when network communication established (replaced by antenna when Roaming is off)
	The instrument is not equipped with a radio (no icon)
	Wireless strength (0 to 5 bars) 1 bar = Network joined, signal very low RSSI (less than 20%) 2 bars = Network joined, signal low RSSI (21% to 40%) 3 bars = Network joined, signal medium RSSI (41% to 60%) 4 bars = Network joined, signal good RSSI (61% to 80%) 5 bars = Network joined, signal very good RSSI (81% to 100%)
	Pump status (only on pump-equipped models)
	Datalogging status (shown when datalogging is on, blank when off)
	Battery status (three segments show battery charge level)
	Man Down alarm enabled

QRAE 3 User's Guide

Icon	Function
✓	All sensors tested and calibrated tick mark (all sensors have been bump tested and calibrated; no sensor is overdue for a bump test or calibration according to the intervals configured on the instrument)

3.1.2. LCD Flip

The QRAE 3 senses its vertical/horizontal orientation, and can automatically flip the display 180 degrees, making it easy to read if the QRAE 3 is upside down. (You can turn this feature on or off in Programming Mode, under “Monitor.”) As the QRAE 3 is tilted, the sensor detects its orientation and inverts the screen when it passes its horizontal position.

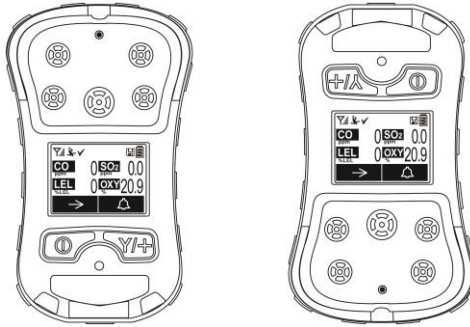

3.1.3. Keys & Interface

The QRAE 3 has two keys:

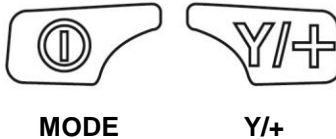

In addition to their labeled functions, the keys labeled [MODE] and [Y/+] act as “soft keys” that control different parameters and make different selections within the instrument’s menus. From menu to menu, each key controls a different parameter or makes a different selection.

Two panes along the bottom of the display are “mapped” to the keys. These change as menus change, but at all times the left pane corresponds to the [MODE] key, and the right pane corresponds to the [Y/+] key. Here are examples that show the relationships of the keys and functions:

In addition to the functions described above, either key can be used to manually activate display backlighting. Press a key when the backlighting is off to turn it on.

QRAE 3 User's Guide

3.2. Screen Display For Various Numbers Of Active Sensors

The QRAE 3 family of instruments can accommodate from one to four sensors. In order to maximize readability and the amount of information shown, the display is automatically reconfigured, according to the number and types of sensors in the QRAE 3.

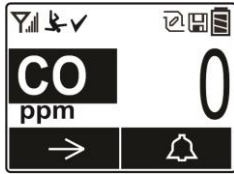

One sensor.



Two sensors.

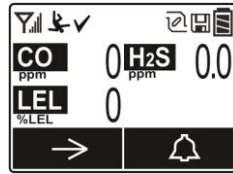

Three sensors.

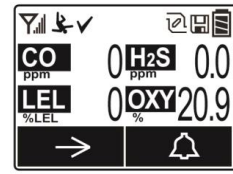

Four sensors.

3.3. Menus

The reading menus are easy to step through by pressing the [MODE] and [Y/+] key.

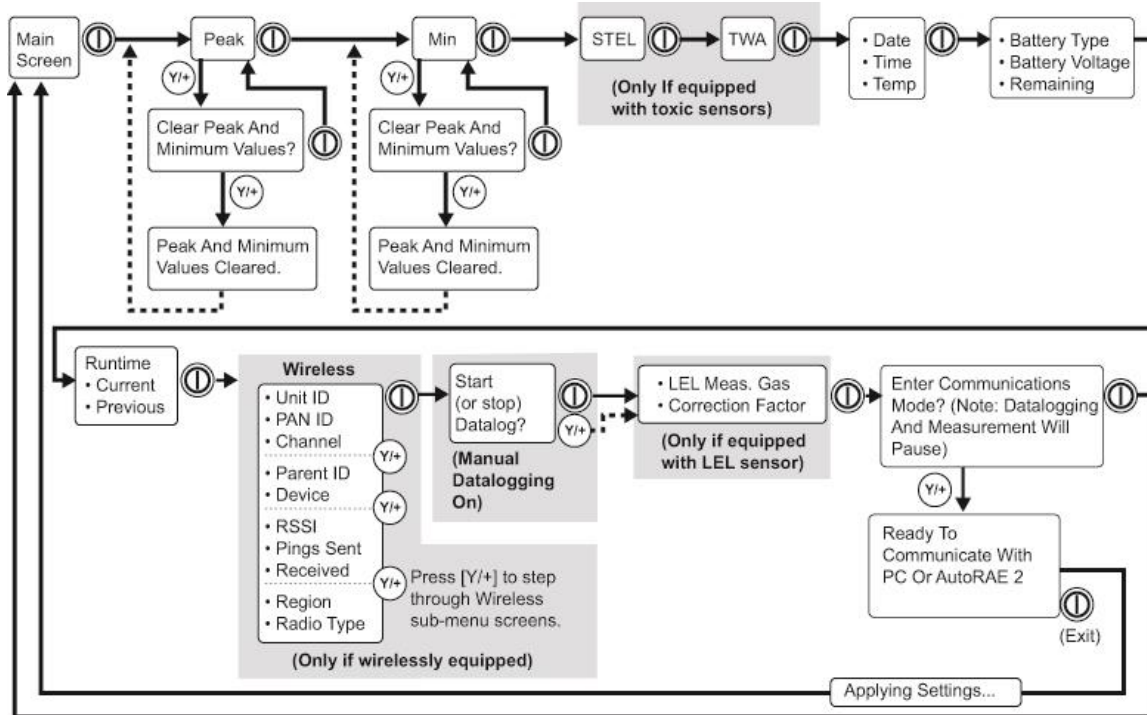

4. Wireless Control And Submenus

When you step through the main menu, as shown in the previous diagram, there are four screens for wireless communication, containing information on wireless settings and status.

Note: These are only present if the QRAE 3 is equipped with a wireless module.

QRAE 3 User's Guide

5. Battery

Always fully charge the battery before using the QRAE 3. Its Li-ion battery is charged by placing the QRAE 3 in its Travel Charger. Contacts on the bottom of the instrument meet the Travel Charger's contact pins, transferring power.

Battery pack (P/N G02-3004-000) is used for QRAE 3.

Note: Before attaching the QRAE 3 to its Travel Charger, visually inspect the contacts to make sure they are clean. If they are not, wipe them with a soft, dry cloth. Do not use solvents or cleaners.

WARNING

To reduce the risk of ignition of hazardous atmospheres, recharge, remove or replace the battery only in an area known to be non-hazardous! Do not mix old and new batteries or batteries from different manufacturers.

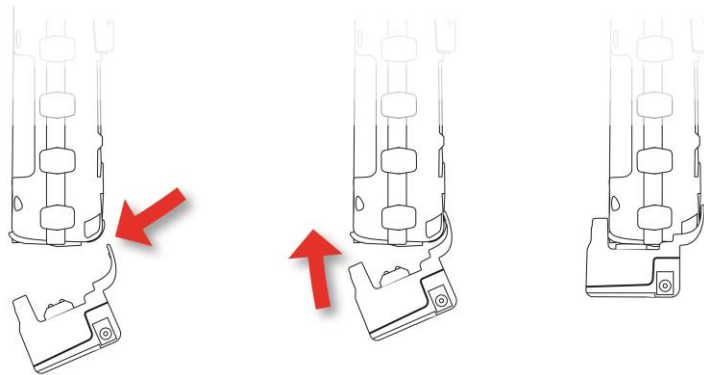

Catch the lip of the Travel Charger on the front of the QRAE 3

Tilt the Travel Charger up

Click the latch into place

Next, put the plug from the power supply into the jack on the side of the Travel Charger.

Note: For ATEX/IECEX applications, plug the cord from the Barrier Box (P/N M02-3011-000) into the Travel Charger, and then plug the power adapter into the Barrier Box.

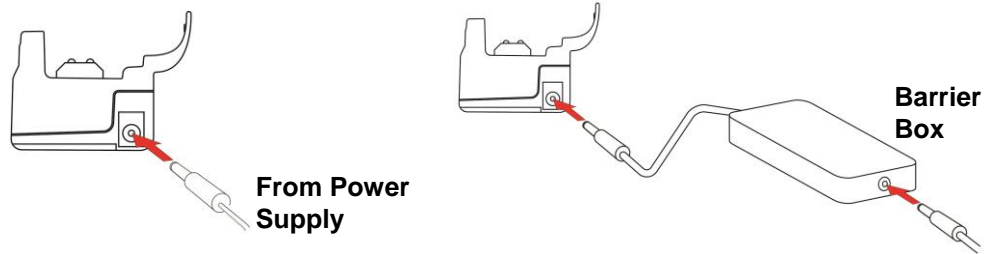

Non-ATEX/IECEX: Power supply plugged directly into Travel Charger.

ATEX/IECEX: Barrier Box Between power supply and Travel Charger.

Plug the other end of the charger into a power source (AC outlet or 12VDC mobile power port, depending on the model). When power is applied and the QRAE 3's battery is charging, the LED glows red. The LED glows green when the battery is fully charged.

QRAE 3 User's Guide

5.1. Replacing The Battery

To replace the QRAE 3 battery:

1. Remove the two screws that hold the battery compartment cover in place.



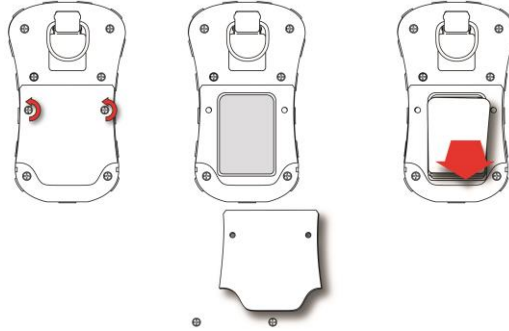

Note: It is not necessary to remove the belt clip.



2. Remove the cover plate by tilting up the end closest to the belt clip and lifting off.
3. Slide the QRAE 3's battery out of its compartment and into your hand.
4. Press a fully charged battery into the battery compartment and place it in the instrument. Pay careful attention to the direction of the battery so that the electrical contacts are on the bottom.
5. Replace the cover and tighten the two screws to secure the battery.

5.2. Battery States

The battery icon on the display shows how much charge is in the battery and alerts you to any charging problems.

				
Full charge	2/3 charge	1/3 charge	Low charge	Battery alert

When the battery's charge falls below a preset voltage, the instrument warns you by beeping once and flashing once every minute, and the "empty battery" icon blinks on and off once per second. The instrument automatically powers down within 10 minutes, after which you will need to either recharge the battery, or replace it with a fully charged one.



6. Turning The QRAE 3 On And Off

6.1. Turning The QRAE 3 On

With the instrument turned off, press and hold the [MODE] key until the audible alarm stops, and then release.

When starting up, the QRAE 3 turns the backlight on and off, beeps once, blinks once, and vibrates once. A RAE Systems logo should appear first. During a normal startup, this is followed by a progression of screens that tell you the QRAE 3's current settings:

- Product name and model number, air flow type, and serial number
- Application firmware version, build date, and build time
- Installed sensors (including production/expiration/calibration date and alarm limit settings)
- Current date, time, and temperature
- User mode and operation mode
- Battery type, voltage, shutoff voltage
- Alarm mode and alarm settings
- Datalog period (if it is activated) and interval
- Policy Enforcement settings

Then the QRAE 3's main reading screen appears. It takes 1 to 2 minutes for sensors to show a reading, so if any have not warmed up by the time the main screen is shown, you will see "--" instead of a numerical value until the sensor provides data (typically less than 2 minutes). Then it displays instantaneous readings similar to the following screen (depending on the sensors installed) and is ready for use.

Note: If the battery is completely empty, then the display briefly shows the message "Battery Fully Discharged," and the QRAE 3 shuts off. You should charge the battery or replace it with a fully charged battery before turning it on again.

IMPORTANT!

If a major error that prevents the QRAE 3 from functioning is found during startup, the message "Please Contact Service Department" is shown on the display. The instrument should be shut off and serviced.

6.2. Turning The QRAE 3 Off

Press and hold [MODE]. A 5-second countdown to shutoff begins. You must hold your finger on the key for the entire shutoff process until the QRAE 3 is powered off.

Caution: The alarm is very loud. During startup, you can mute most of the sound by holding a finger over the alarm port. Do not put tape over the alarm port to permanently mute it.

6.3. Testing Alarm Indicators

Under normal-operation mode and non-alarm conditions, the buzzer, vibration alarm, LED, and backlight can be tested at any time by pressing [Y/+] once.

IMPORTANT!

If any of the alarms do not respond to this test, check the Alarm Settings in Programming Mode. It is possible that any or all of the alarms have been turned off. If all of the alarms are turned on, but one or more of them (buzzer, LED lights, or vibration alarm) does not respond to this test, do not use the instrument. Contact your RAE Systems distributor for technical support.

6.4. Pump Status

IMPORTANT!

During operation, make sure the probe inlet and the gas outlet are free of obstructions. Obstructions can cause premature wear on the pump, false readings, or pump stalling. During normal operation, the pump icon alternately shows inflow and outflow as shown here:



If there is a pump failure or obstruction that disrupts the pump, the alarm sounds and you see this icon blinking on and off:



Once the obstruction is removed, you can restart the pump by pressing the [Y/+] key. If the pump does not restart, and the pump stall alarm continues, consult the Troubleshooting section of this guide or contact your RAE Systems distributor for technical support.

Note: Pump Status is not indicated on the diffusion QRAE 3.

6.5. Calibration Status

If one or more sensors requires calibration, then the screen displays the word “Alarm” at the top and alternates between the sensor reading and the word “Cal” with a highlighted background:



Calibration is required if:

- The sensor module has been replaced with one whose calibration is overdue.
- The defined period of time between calibrations has been exceeded. (See Section 9 for information on policy enforcement.)
- If you have changed the calibration gas type without recalibrating the instrument.
- The sensor has failed a previous calibration.

QRAE 3 User's Guide

6.6. Bump Status

If one or more sensors requires a bump test, then the screen displays the word “Alarm” at the top and alternates between the sensor reading and the word “Bump” with a highlighted background:



A bump test is required if the defined period of time between bump tests has been exceeded. This interval is set by an administrator using ProRAE Studio II.

7. Modes Of Operation

The QRAE 3 has two user modes.

7.1. Basic User Mode

In Basic User Mode, some restrictions are applied, including password protection that guards against entering Programming Mode by unauthorized personnel.

7.2. Advanced User Mode

In Advanced User Mode, there are no access restrictions (you do not need a password), and the QRAE 3 provides the indications and data you need most for typical monitoring applications.

8. Programming

The menu in Programming Mode is to adjust settings, calibrate sensors, and initiate communication with a computer. It has the following submenus:

- Calibration
- Measurement
- Alarms
- Datalog
- Monitor
- Wireless

8.1. Enter Programming In Basic Mode

1. To enter Programming Mode, press and hold [MODE] and [Y/+] until you see the Password screen.

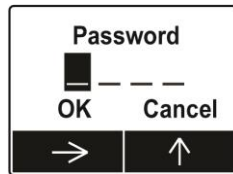

2. Input the 4-digit password:

- Increase the number from 0 through 9 by pressing [Y/+].
- Step from digit to digit using [MODE].
- After inputting the password's four digits, advance to "OK."
- Press [Y/+] to register the password and enter Programming Mode. Otherwise, advance to "Cancel" then press "[Y/+]."

If you make a mistake, you can cycle through the digits by pressing [MODE] and then using [Y/+] to change the number in each position.

Note: The default password is 0000.

Note: The password screen only appears when you enter the Programming Mode the first time after turning the instrument on in Basic Mode. If you have input the correct password, you do not have to input it again to enter Programming Mode until you turn the instrument off and on again.

QRAE 3 User's Guide

Once you enter Programming Mode, the Calibration screen is shown. Press [MODE] to step through the programming screens.

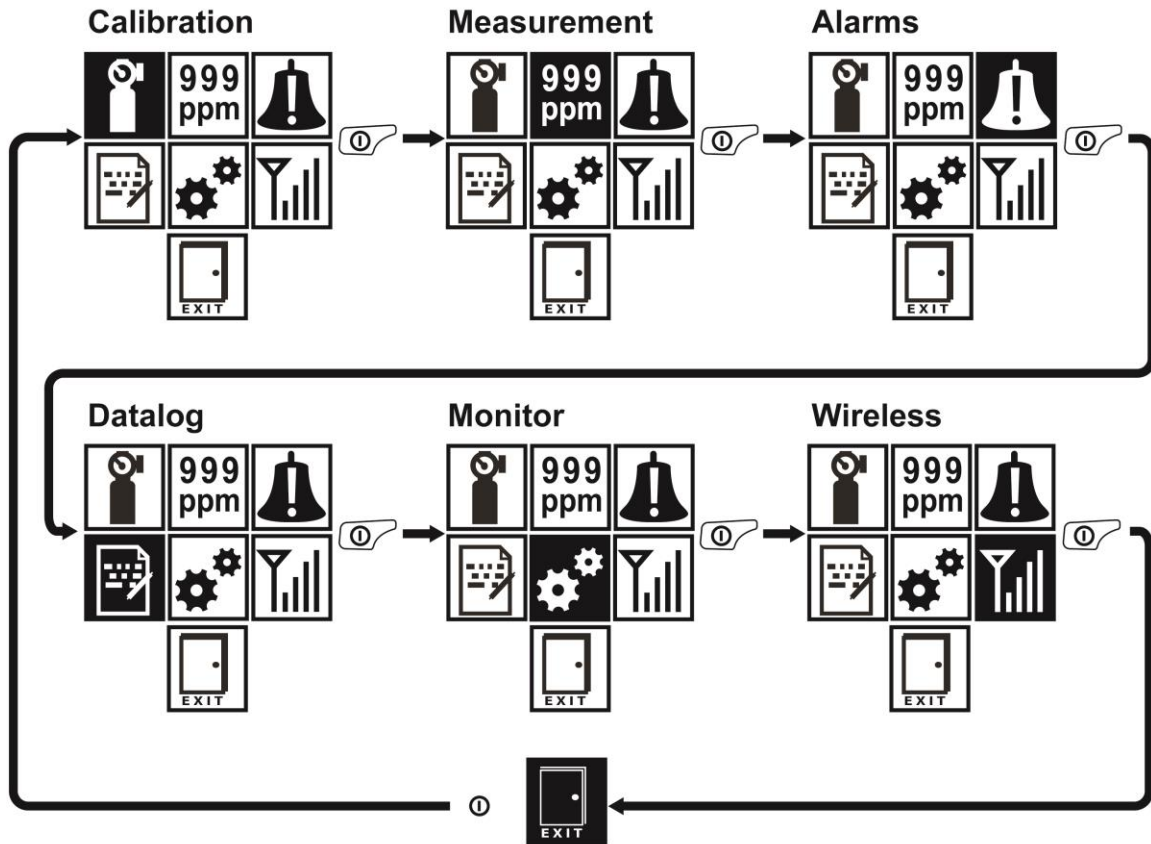

To enter a menu and view or edit parameters in its submenus, press [Y/+].

8.2. Enter Programming In Advanced Mode

1. To enter Programming Mode, press and hold [MODE] and [Y/+] until you see the Calibration screen. No password is necessary in Advanced Mode.
2. Press [MODE] to step through the programming screens.

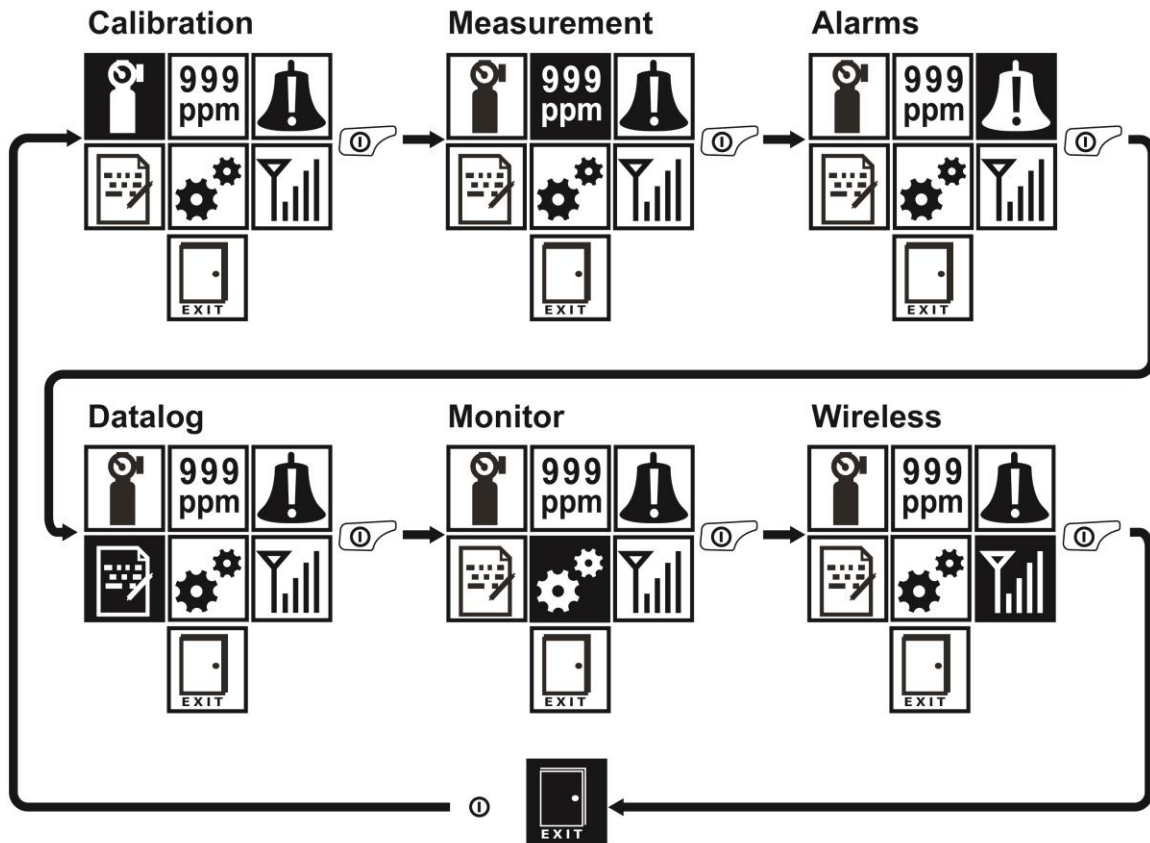







To enter a menu and view or edit parameters in its submenus, press [Y/+].

QRAE 3 User's Guide

8.3. Menus And Submenus

In Programming Mode, menus and submenus are organized as shown here:

					
Calibration	Measurement	Alarms	Datalog	Monitor	Wireless*
Multi Bump	Sensor On/Off	Alarm Limits	Clear Datalog	Date And Time	Radio On/Off
Multi Zero	Meas. Unit	Alarm Mode	Interval	Display	Roaming
Multi Span	LEL Meas. Gas	Alarm Settings	Sensor Selection	Pump Speed**	PAN ID
Single Bump	Exit	Comfort Beep	Data Selection	Site ID	Channel
Single Zero		Man Down Alarm	Datalog Type	User ID	Join Network
Single Span		Exit	Action When Full	User Mode	Interval
Set LEL Cal. Gas			Exit	Zero At Start	Off Network Alarm
Set Span Value				Exit	Factory Reset
Exit					Exit

* Wirelessly equipped versions only.

** Pump-equipped version only.

8.3.1. Editing And Selecting Parameters And Sensors

There are a few basic ways to edit parameters, select sensors, and perform other activities in the QRAE 3. The actions performed by pressing keys always match 1-to-1 with the boxes along the bottom of the display and the two keys. Some parameters are edited by scrolling and selecting individual items (black bars behind white text act as highlighters). Some include a choice via “radio keys,” where only one item in a list can be selected, while other menus use boxes for you to “check” with an “X,” and these allow for multiple items in a list to be selected. In all cases of editing, you can save or undo your choice.

QRAE 3 User's Guide

8.3.2. Calibration

Use this menu to perform zero or span calibration for one or more sensors, and change the gas concentration value assumed to be used in span calibration, as well as zero calibration and calibration reference gas.

8.3.2.1. Multi Bump

Depending on the configuration of your QRAE 3 and the span gas you have, you can perform a bump test simultaneously on multiple sensors.

The selected sensors and their values are shown on the screen. With calibration gas connected to the instrument, start a multiple bump test by pressing [Y/+]. If you do not want to perform a multiple bump test, press [MODE].

Note: You can abort a multiple bump test by pressing [MODE] once testing has started.

When the Multi Bump test is done, a screen is shown, with the sensor names and either “Pass” or “Fail” shown next to them.

8.3.2.2. Multi Zero

You can perform a zero calibration simultaneously on multiple sensors. This procedure determines the zero point of the sensor calibration curve for all the sensors that require a zero calibration. The instrument should be zero calibrated in clean ambient air with 20.9% oxygen. A zero calibration should precede a span calibration.

The selected sensors are shown on the screen. Start a multiple zero test by pressing [Y/+]. If you do not want to perform a test, press [MODE].

Note: You can abort a multiple zero test by pressing [MODE] once testing has started.

When the Multi Zero test is done, a screen labeled Calibration Results is shown, with the sensor names and either “Pass” or “Fail” shown next to them.

8.3.2.3. Multi Span

Depending on the configuration of your QRAE 3 and the span gas you have, you can perform a span calibration simultaneously on multiple sensors.

The selected sensors and their values are shown on the screen. With calibration gas connected to the instrument and turned on, start a multiple span calibration by pressing [Y/+]. If you do not want to perform a multiple span calibration, press [MODE].

Note: You can abort a multiple span calibration by pressing [MODE] once testing has started.

When the Multi Span calibration is done, a screen labeled Calibration Results is shown, with the sensor names and either “Pass” or “Fail” shown next to them.

8.3.2.4. Single Bump

You can perform a separate bump test on each individual sensor.

The active sensors' names are shown in a list. Press [MODE] to highlight the sensor you want to bump test, and then press [Y/+] to select it.

QRAE 3 User's Guide

When the Apply Gas screen is shown, connect the calibration gas to the instrument, and start the bump test by pressing [Y/+]. If you do not want to perform a single bump test, press [MODE] to quit.

Note: You can abort a bump test by pressing [MODE] once testing has started.

When the Multi Bump test is done, a screen is shown, with the sensor names and either “Pass” or “Fail” shown next to them.

8.3.2.5. Single Zero

This allows you to perform zero (fresh air) calibration on individual sensors. The instrument should be zero calibrated in clean ambient air with 20.9% oxygen. A zero calibration should precede a span calibration.

The active sensors' names are shown in a list. Press [MODE] to highlight the sensor you want to zero calibrate, and then press [Y/+] to select it.

When the Zero Calibration screen is shown with the sensor name and its measurement unit, start the zero calibration by pressing [Y/+]. If you do not want to perform a calibration, press [MODE] to quit.

Note: You can abort a zero calibration by pressing [MODE] once testing has started.

When the zero calibration is done, the Calibration Results screen is shown with either “Pass” or “Fail” shown.

8.3.2.6. Single Span

Instead of performing a span calibration on more than one sensor simultaneously, you can select a single sensor and perform a span calibration.

The active sensors' names are shown in a list. Press [MODE] to highlight the sensor you want to span calibrate, and then press [Y/+] to select it.

When the Apply Gas screen is shown with the sensor name and its measurement unit, connect a cylinder of span gas, start its flow, and then start the zero calibration by pressing [Y/+]. If you do not want to perform a span calibration, press [MODE] to quit.

Note: You can abort a span calibration by pressing [MODE] once testing has started.

When the span calibration is done, the Calibration Results screen is shown with either “Pass” or “Fail” shown.

8.3.2.7. Set LEL Cal. Gas

For best response, it is desirable to calibrate an LEL sensor with the specific gas that you are surveying (target gas). Changing the gas requires selecting the right calibration reference gas in the QRAE 3. Choose the sensor, and then select from the list of reference gases. Select from a Custom Gases list that you create or the built-in Gas Library for your sensor (taken from RAE Systems' Technical Note TN-156 or the table at the end of this user's guide).

Choose Custom Gases or Gas Library by pressing [MODE], and then press [Y/+] to make your selection.

QRAE 3 User's Guide

Up to eight custom gases are in the library. Scroll through the choices by pressing [Y/+], and then select the custom gas configuration by pressing [MODE] to highlight it. With "Save" highlighted, press [Y/] to save your choice.

If you choose from the Gas Library, press [Y/] to scroll through the list, and then press [MODE] to make your selection. With "Save" highlighted, press [Y/] to save your choice. The gas is saved, and then the screen briefly shows the Correction Factor applied to that gas by the QRAE 3.

Note: The Gas Library contains many gases. To rapidly scroll through the list, press and hold [Y/].

8.3.2.8. Set Span Value

You can individually set the span gas value for each sensor. The units of measure (ppm, %LEL, etc.) are shown on the display.

Press [MODE] to scroll through the list of active sensor names. Then press [Y/] to select one.

Set the span value by pressing [Y/] to increase a value, and pressing [MODE] to advance through the digits.

Once your span value is input, press [MODE] to advance and highlight "OK." Press [Y/] to register the change and to advance to the next sensor in the list.

When you reach the end of the list, press [MODE] to highlight "Exit," and then press [Y/] to select it.

8.3.3. Measurement

The submenus for Measurement include Sensor On/Off, Change Measurement Gas, and LEL Measurement Units.

8.3.3.1. Sensor On/Off

You can turn sensors on or off via this set of submenus. An "X" in a box to the left of a sensor's name indicates it is turned on.

1. Press [MODE] to advance down the list of sensors.
2. Press [Y/] to select/deselect a sensor.
3. Press [MODE] until "Exit" is selected.
4. Press [Y/] to save your selection and exit to the Measurement menu.

8.3.3.2. Meas. Unit

The measurement unit for displaying data from sensors can be changed. Your options are ppm (parts per million) mg/m³ (milligrams per cubic meter), and $\mu\text{mol/mol}$ (micromoles per mole).

1. Press [MODE] to move between measurement units.
2. Press [Y/] to select a measurement unit.
3. Press [MODE] until "Exit" is selected.
4. Press [Y/] to save your selection and exit to the Measurement menu.

QRAE 3 User's Guide

8.3.3.3. LEL Meas. Gas

Note: The LEL Measurement Gas option is only available if an LEL sensor is installed.

The QRAE 3 has extensive onboard gas libraries for combustible gases that you can use to configure your instrument to automatically apply the appropriate correction factors and produce readings in the units of the desired combustible gas.

LEL measurement gases are organized in two lists:

- **Custom Gases** are gases with user-modified parameters. Using ProRAE Studio II, all parameters defining a gas can be modified, including the name, span value(s), correction factor, and default alarm limits.
- **Gas Library** is a library that consists of many of the gases found in RAE Systems' Technical Note TN-156 (available online at www.raesystems.com). Methane is the default gas.

Choose Custom Gases or Gas Library by pressing [MODE], and then press [Y/+] to make your selection.

Up to eight custom gases are in the library. Scroll through the choices by pressing [Y/+], and then select the custom gas configuration by pressing [MODE] to highlight it. With "Save" highlighted, press [Y/+] to save your choice.

If you choose from the Gas Library, press [Y/+] to scroll through the list, and then press [MODE] to make your selection. With "Save" highlighted, press [Y/+] to save your choice.

Note: The Gas Library contains many gases. To rapidly scroll through the list, press and hold [Y/+].

8.3.3.4. Alarms

Use this menu to change high, low, STEL, and TWA alarm limits - the points at which alarms are triggered. It can also change alarm mode (latched or automatic reset) and alarm output methods (combinations of light, buzzer, and vibration alarm indications).

8.3.3.5. Alarm Limits

There are four groups of alarm settings that you can adjust for each individual sensor for which a particular alarm type is available.

Settings:

- High Alarm
- Low Alarm
- STEL Alarm
- TWA Alarm

Note: Some alarm settings are not applicable to all sensors. If a setting is irrelevant to a sensor (in some cases STEL or TWA are not relevant to a sensor), then that sensor does not appear in the list for alarm limits.

QRAE 3 User's Guide

8.3.3.6. Alarm Mode

You can program the QRAE 3 so that there are two ways to shut off an alarm:

Auto Reset	When the alarm condition is no longer present, the alarm stops and resets itself.
Latch	The latched setting only controls alarms for High Alarm, Low Alarm, STEL Alarm, and TWA alarm. When an alarm is in “latched” mode, the alarm signal remains on even when the alarm condition is no longer present Press [Y/+] to acknowledge and reset alarm signals.

8.3.3.7. Alarm Settings

You can enable/disable any combination of light (LEDs), buzzer, and vibration alarms.

Settings:

- All Enabled
- Light
- Vibration
- Buzzer
- Buzzer & Light
- Buzzer & Vibration
- Vibration & Light
- All Disabled

8.3.3.8. Comfort Beep

A Comfort Beep is a single beep of the audible alarm at 60-second intervals that reminds the person using the QRAE 3 that it is functioning. It can be turned on or off.

8.3.3.9. Man Down Alarm

The Man Down Alarm is a critical and potentially lifesaving safety feature of every QRAE 3. The Man Down Alarm is based on the premise that if the instrument is motionless when it is not supposed to be, something wrong may be happening to its user. If that is the case, the QRAE 3 not only goes into alarm locally on the instrument, but also remotely, over the RAE Systems Dedicated Wireless Network, to notify people in the vicinity, as well as remote safety officers at a command center, that a person is down, so that help can be dispatched quickly.

Note: Remote notification requires wireless connection to a network.

Whenever the Man Down feature is on, the main screen displays a Man Down icon along the top to indicate it is active:



QRAE 3 User's Guide

When the Man Down feature is on and there is no gas alarm, the QRAE 3 senses that it is motionless for the amount of time set in the “Motionless Time” parameter. If the instrument is not moved during that time, then a pre-alarm is activated to alert the user, and shows the “Are You OK?” screen. Pressing [Y/+] clears the alarm and returns the QRAE 3 to its normal operation. Pressing [MODE] sets it into Man Down Alarm (and if wireless connectivity is enabled, a Man Down message is sent in real time to remote observers). If neither key is pressed, then after the countdown, it goes into Man Down Alarm (again sending a message to remote observers if wirelessly enabled).

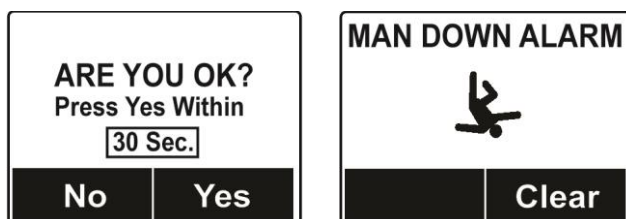

Settings are available for:

- Off/On
- Motionless Time (time the instrument is motionless before initiating a pre-alarm)
- Sensitivity (set to low, medium, or high to compensate for ambient vibration or motion)
- Warning Time (countdown, in seconds, from pre-alarm to Man Down alarm)

When the Man Down alarm is activated, the buzzer sounds and LEDs flash continuously, and a countdown begins.

- If the QRAE 3's user presses [Y/+] for “Yes” in response to the “Are You OK?” question on the screen before the countdown reaches zero, the Man Down alarm stops and the main reading screen is displayed.
- If the person does not press [Y/+] for “Yes” in response to the “Are You OK?” question on the screen before the countdown reaches zero, the Man Down alarm is sounded and LEDs flash continuously.
- If the person presses [MODE] during the countdown, answering the “Are You OK?” question with “No,” the Man Down alarm starts.

If wireless connectivity is enabled, and the QRAE 3 is connected to a network, a Man Down message is also sent to remote observers.

8.3.4. Datalog

The instrument displays a floppy disk icon to indicate that a datalog is being recorded. The instrument stores the measured gas concentration for each sensor, date and time for each measurement, Site ID, User ID, and other parameters. The QRAE 3 memory is sufficient to record three months' worth of data for four sensors at one-minute intervals. All data are retained (even after the unit is turned off) in non-volatile memory so that they can be downloaded at a later time to a PC.

8.3.4.1. Clear Datalog

This operation erases all data stored in the datalog.

Note: Once the datalog is cleared, the data cannot be recovered.

QRAE 3 User's Guide

8.3.4.2. Interval

Intervals are shown in seconds. The default value is 60 seconds. The maximum interval is 3600 seconds, and the minimum is 1 second.

8.3.4.3. Sensor Selection

You can choose which sensors' data are included in the datalog. The entire list of installed sensors is shown, and you can individually select whether their data is included.

Note: Turning a sensor off in the list does not change or erase its settings.

8.3.4.4. Data Selection

Data Selection allows you to select which types of data are stored and made available when you download your datalog to a computer via ProRAE Studio II (version 1.7.0 or higher) software. You can choose any or all of four types of data (you must choose at least one):

- Minimum
- Average
- Maximum
- Real Time

8.3.4.5. Datalog Type

The instrument offers two options for starting the datalogging process:

Auto Automatically collects datalog information every time the instrument is sampling until the datalog memory is full.

Manual Datalogging occurs only when you manually initiate it (see below for details).

Note: You can only choose one datalog type to be active at a time.

About Manual Datalog

When the instrument is set to Manual Datalog, you can turn datalogging on and off by repeatedly pressing [MODE] and stepping through the screens from the main display until you reach the screen that says "Start Datalog?"

- When you reach the screen that says "Start Datalog?" press [Y/+] to start it. You see "Datalog Started," confirming that datalogging is now on.
- If datalogging is running, it says, "Stop Datalog?" Press [Y/+] to stop datalogging. Otherwise, press [MODE] to advance to the next screen.

8.3.4.6. Action When Full

When the internal datalog memory is full, the QRAE 3 can either stop collecting data (Stop when full) or go back to the beginning and overwrite the data from the first entry, second entry, etc. (Wraparound).

8.3.5. Monitor

The submenus under "Monitor" control the LCD's contrast, operation mode, pump speed, and other parameters.

QRAE 3 User's Guide

8.3.5.1. Date And Time

Date

Month (MM) and Day (DD) have two digits each, while the year (YYYY) uses four digits.

Time

The QRAE 3's time must be set using the 24-hour format, following hours, minutes, and seconds (HH:MM:SS).

8.3.5.2. Display

LCD Contrast

The display's contrast can be increased or decreased from its default setting. You may not need to ever change the default setting, but sometimes you can optimize the display to suit extreme temperature and ambient brightness/darkness conditions.

Use the [Y/+] key to change the LCD contrast. When you are done, press [MODE] to highlight "OK" and press [Y/+] to save your change. Otherwise, highlight "Cancel" and press [Y/+] to abort changes and revert to the original setting.

LCD Flip

The display can be configured to flip 180° automatically when the QRAE 3 is turned upside-down. The LCD Flip feature can be set to On or Off.

Backlight

The display's backlight can be set to illuminate either automatically, based on ambient light conditions, or manually, or it can be shut off.

8.3.5.3. Pump Speed

If the QRAE 3 is equipped with a pump, the pump can operate at two speeds, high and low. Running at low speed is quieter, extends pump lifespan, and conserves a small amount of power. There is almost no difference in sampling accuracy. **Note:** High speed should be used for exotic sensors and for taking samples via a hose from a long distance.

8.3.5.4. Site ID

Choose and enter an 8-digit Site ID to uniquely identify the particular site where the instrument is to be used. The first four digits can be an alphabet letter or number, while the last four digits can only be numbers. This Site ID is included in the datalog report.

Note: Advance through the alphabet and numbers (0 through 9) by one with each press of the [Y/+] key. To scroll quickly, hold down the [Y/+] key for as long as you want it to scroll rapidly. Save your changes by highlighting "OK" and pressing [Y/+].

8.3.5.5. User ID

Enter an 8-digit alphanumeric User ID to uniquely identify a user. This User ID is included in the datalog report.

QRAE 3 User's Guide

Note: Advance through the alphabet and numbers (0 through 9) by one with each press of the [Y/+] key. To scroll quickly, hold down the [Y/+] key for as long as you want it to scroll rapidly. Save your changes by highlighting "OK" and pressing [Y/+].

8.3.5.6. User Mode

Two User Modes are available: Advanced and Basic. The Advanced User Mode allows a greater number of parameters to be changed than Basic User Mode. No password is required to enter the Programming Menu when in Advanced User Mode.

8.3.5.7. Zero At Start

If your QRAE 3 has been configured to perform a zero (fresh air) calibration upon startup, called Zero At Start, then the startup routine is interrupted so that you can perform a fresh air calibration.

Press [Y/+] to start zero calibration when prompted. If you do not want to perform a zero calibration, press [MODE] to bypass it. If you start a zero calibration and want to abort it, press [MODE], and the calibration stops and the main display is shown.

8.3.6. Wireless

When a QRAE 3 is equipped with a wireless modem, its settings are controlled via the menu items under "Wireless."

8.3.6.1. Radio On/Off

Turn the radio on or off via this menu.

1. Choose between "On" and "Off" by pressing [MODE].
2. Select the highlighted state by pressing [Y/+].
3. Press [MODE] until Exit is selected to register the change.
 - Press [Y/+] to save the change. You see the message "Turning On Radio. Please Wait." or (if you are turning off the radio) it simply advances to the Wireless menu screen.

8.3.6.2. Roaming

The Roaming function provides continuous wireless connectivity between zones enabling users of wireless monitors to travel from one zone/work area to another without losing communication between their monitor and ProRAE Guardian. You can turn Roaming on and off in your monitor, or you can set it via ProRAE Studio II.

1. In the Wireless menu, press [MODE] to scroll down to "Roaming."
2. Press [Y/+] to select "Roaming."
3. Press [MODE] to scroll to "On" or "Off."
4. Press [MODE] to scroll to "Exit."
5. Press [Y/+] to exit.

Note: When Roaming is on, you cannot change the instrument's PAN ID. In addition, when Roaming is on, the "PAN ID" is not shown in the Wireless menu. To turn "PAN ID" back on:

1. In the Wireless menu, press [N/-] to scroll down to "Roaming."
2. Press [Y/+] to select "Roaming."

QRAE 3 User's Guide

3. Press [MODE] to scroll from "On" to "Off."
4. Press [Y/+] to select "Off."
5. Press [MODE] to select "Exit."
6. Press [Y/+] .

The screen says "Apply Settings" and then goes to the Wireless Menu. Roaming is now off, and the "PAN ID" menu item is now visible and selected.

8.3.6.3. PAN ID

The QRAE 3 and any other devices that you want to connect wirelessly must have the same PAN ID. **Note:** When Roaming is on, "PAN ID" is not shown in the Wireless menu. You must turn off Roaming to make the "PAN ID" menu item visible and accessible.

1. With "PAN ID" selected in the Wireless menu, press [Y/+] to select it.
2. Press [Y/+] to increase the number and [MODE] to advance to the next digit.
3. After moving to the last digit and making changes, press [MODE].
 - Press [Y/+] to save the change.
 - Press [MODE] to undo the change.

8.3.6.4. Channel

The QRAE 3 and any other devices that you want to connect wirelessly must be operating on the same channel.

1. Press [Y/+] to increase the number and [MODE] to advance to the next digit.
2. After moving to the last digit and making changes, advance to "OK" and press [MODE] to save the change, or advance to "Cancel" and exit to "Join Network" without saving the change.

8.3.6.5. Join Network

You can tell the QRAE 3 to automatically join a network. The PAN ID and Channel are shown for reference (if either is incorrect, you can change it, as described above). Press [Y/+] to join or [MODE] to advance to "Interval" without making a change. **Note:** If Roaming is turned on, instead of a PAN ID number, you see "- - -".

While it is searching for a network to join, the display shows this message:

Joining Network...

If it is unsuccessful, you will see this message:

Failed To
Join Network

Check your other settings, as well as those of the network you are trying to join.

You can press [Y/+] to retry or [MODE] to exit without joining a network.

QRAE 3 User's Guide

8.3.6.6. Interval

This menu allows you to change the interval between wireless transmissions. The interval can be set to 10, 30, 60, 120, or 240 seconds.

Note: The default interval is 30 seconds.

8.3.6.7. Off Network Alarm

If you would like the QRAE 3 to notify you when it loses connection with a network, turn this on.

1. Choose between “On” and “Off” by pressing [MODE].
2. Select the highlighted state by pressing [Y/+].
3. Press [MODE] until Exit is selected, to register the change.

Note: When wireless network connection is lost, the QRAE 3 alarms once per second.

8.3.6.8. Factory Reset

Restore all the wireless settings to their original factory defaults.

Caution! Once you reset the wireless settings, you cannot retrieve any of the settings deleted by performing this reset.

Reset Wireless
Settings?

- Press [Y/+] to reset the wireless settings.
- Press [MODE] to exit without resetting the wireless settings.

9. Policy Enforcement

The QRAE 3 can be configured to enforce a facility/company's requirements that calibration and/or bump testing be performed at specified intervals, and to warn the user that calibration/bump testing is required. In addition, it can require calibration or bump testing and not allow normal operation of the instrument unless calibration or bump testing is performed.

If Policy Enforcement is enabled and if the instrument has been bump tested and calibrated in compliance with the policy settings, a check-mark icon is included along the top of the QRAE screen:



If Policy Enforcement is enabled, then after startup the QRAE 3 displays a screen that informs the user that the instrument requires either a bump test or a calibration. If both are required, then they are shown in sequence.

9.1. Setting Policy Enforcement

You must use ProRAE Studio II to make changes to Policy Enforcement settings.

Make sure the AC adapter is connected and that a USB cable is connected to the Travel Charger and a computer running ProRAE Studio II.

1. Turn on the QRAE 3. Allow the system to start up and go through its startup routine.
2. Press [MODE] until "Enter Communications Mode?" is displayed.
3. Press [Y/+]. The screen now displays: "Ready To Communicate With Computer."
4. Start ProRAE Studio II.
5. Select "Administrator."
6. Input the password (the default is "rae").
7. Click "OK."
8. Click "A" (detects instruments automatically).
9. Click on the instrument's icon when it appears to highlight it.
10. Click "Select."
11. Click "Setup."
12. Click "Policy Enforcement."

QRAE 3 User's Guide

The Policy Enforcement pane is shown:

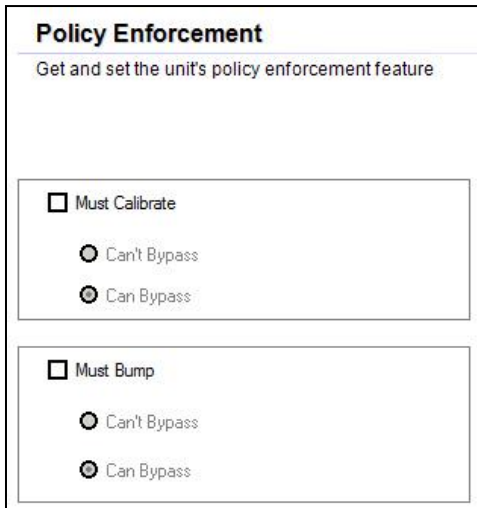

Policy Enforcement
Get and set the unit's policy enforcement feature.

Must Calibrate

Can't Bypass

Can Bypass

Must Bump

Can't Bypass

Can Bypass

You can select “Must Calibrate” and/or “Must Bump” and then set whether the user must perform the selected operation in order to use the instrument.

13. Once you have made your selections in ProRAE Studio II, you must upload the changes to the instrument. Click the icon labeled “Upload current settings to the instrument.”



14. A confirmation screen is shown. Click “Yes” to perform the upload, or “No” to abort.

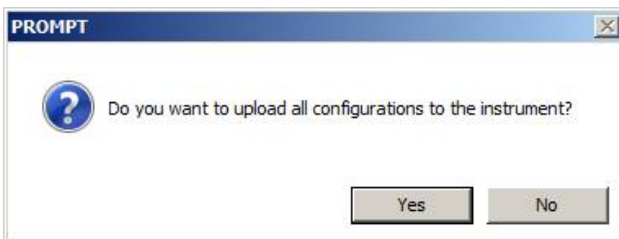

Uploading takes a few seconds, and this progress bar is shown. You can abort the upload by clicking “Cancel.”

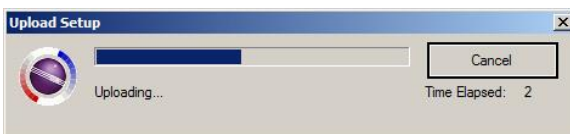

QRAE 3 User's Guide

15. Exit ProRAE Studio II.
16. Press [MODE] on the QRAE 3 to exit Communication Mode.

9.2. Deactivating Policy Enforcement

If the QRAE 3 screen displays the message that it must be bump tested or calibrated, and if the option to bypass bump testing or calibration is not available, you should shut off the instrument and follow the procedure outlined here if you want to change the Policy Enforcement settings:

1. Use a USB cable to connect the QRAE 3 in its Travel Charger to a computer running ProRAE Studio II.
2. Enter Diagnostic Mode on the QRAE 3 (with the instrument turned off, press and hold [Y/+] and [MODE] until it starts up).
3. After startup, enter the password when prompted (default is "0000") and press [MODE].
4. Press [MODE] repeatedly until you see the "Enter Communications Mode?" screen.
5. Press [Y/+] to enter Communications Mode.
6. Start ProRAE Studio II.
7. Select "Administrator."
8. Input the password (the default is "rae").
9. Click "OK."
10. Click "A" (detect instruments automatically).
11. Click on the instrument's icon when it appears.
12. Click "Select."
13. Click "Setup."
14. Click "Policy Enforcement." The Policy Enforcement pane is shown.
15. Deselect Policy Enforcement features you do not wish to use.
16. Click "Upload all settings to the instrument."



17. When you see this confirmation. Click "Yes."

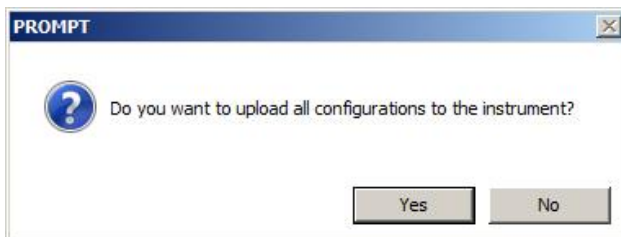

Uploading will take a few seconds, and this progress bar is shown:

QRAE 3 User's Guide

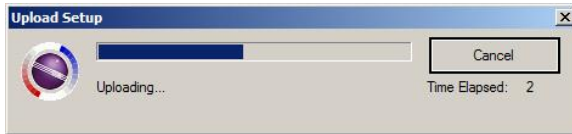

18. When the upload is done, exit ProRAE Studio II.
19. Press [MODE] on the QRAE 3 to exit Communication Mode.

10. Calibration And Testing

10.1. Manual Alarms Test

Under Normal Operation Mode and non-alarm conditions, the buzzer (audible alarm), vibration, visible alarms, and backlight can all be tested anytime by pressing [Y/+]. If any alarm does not respond, check the alarm settings in the Programming Menu to make sure all alarms are enabled (selected setting under Programming/Alarms/Alarm Settings should be “All Enabled”). If any alarms are enabled but not functional, the instrument should not be used.

10.2. Bump Testing And Calibration

RAE Systems recommends that a bump test be conducted periodically on the QRAE 3. The purpose of a bump test is to ensure that the instrument's sensors respond to gas and all the alarms are enabled and functional.

- The QRAE 3 multi-gas detector must be calibrated if it does not pass a bump test, or at least once every 180 days, depending on use and sensor exposure to poisons and contaminants.
- Calibration intervals and bump test procedures may vary due to national legislation.

A bump test can be performed either manually or using the AutoRAE 2 Automatic Test and Calibration System. When a bump test is done manually, the instrument makes a pass/fail decision based on sensor performance, but the user still has the responsibility to make sure all the alarms are enabled and functional.

Note: Bump testing and calibration can be performed using an AutoRAE 2 Automatic Test & Calibration System. An AutoRAE 2 bump test takes care of both the sensor and alarm tests. Consult the AutoRAE 2 User's guide for details.

QRAE 3 User's Guide

10.2.1. Bump (Functional) Testing

The same gas is used for a bump test as for calibration. A constant-flow regulator producing 0.5 to 1 liters per minute should be used, and the calibration adapter must be installed on diffusion models. The instrument must be connected to a cylinder of calibration gas with supplied tubing.

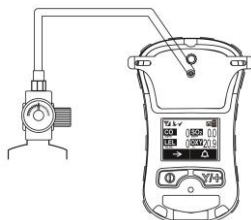

**Diffusion models
require calibration
cap, but no T
calibration tube.**

Note: Pumped models require a T calibration tube, as illustrated below.

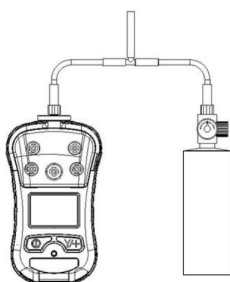

**Note: Make sure pressure in
the calibration gas cylinder
is higher than 100 psi when
using a T calibration tube
(pumped models only).**

1. Turn on your QRAE 3 by pressing and holding the [MODE] key, and allow the instrument to boot up fully until the main measurement screen with sensor names and readings is shown.

Important! Make sure all of the instrument's sensors have warmed up before performing the bump test. The instrument will take the time to warm up the sensors prior to enabling access to bump test menus. You can tell a sensor has warmed up if you see a reading next to its name on the display. If it has not warmed up, you see three dashes (“--”) next to it.

2. Install the calibration adapter on the QRAE 3 if it is a diffusion model.
3. Turn on the gas to initiate flow.
4. Connect the instrument to the T calibration tube and connect it to the calibration gas.
5. Press Start ([Y/+]) key to start the bump test, or press [MODE] to quit. While the bump test is being performed, the readings for each sensor are shown. Once the bump test completes, pass/fail test results and readings are shown for each sensor.

Important! If one or more sensors fails a bump test, be sure to calibrate those sensors.

6. The bump test is now complete. Press [Y/+]) to exit and return to the Calibration menu.

If all the alarms and all sensors have passed and no sensor is due for a calibration, the instrument is now ready for use.

QRAE 3 User's Guide

10.3. Zero Calibration

This operation sets the zero point of the sensor calibration curve for clean air. It should be performed before other calibrations.

Note: If you use a zero air cylinder, you must use the QRAE 3 Calibration Adapter (and a T calibration tube if the instrument has a pump). Using a calibration adapter is not necessary for calibration in fresh air.

10.3.1. Zero Calibration

This procedure determines zero points of most sensors. The QRAE 3 should be zero-calibrated in clean air with 20.9% oxygen or with a cylinder of clean zero air.

At the Calibration menu, select “Fresh Air” by pressing [Y/+] once to enter fresh air calibration.

After a timer countdown, the zero calibration is done. The LCD displays the sensor names and tells you whether each calibration passed or failed, followed by the sensor readings.

Note: You can abort the calibration at any time during the countdown by pressing [MODE].

10.3.2. Single-Sensor Zero Calibration

Select the sensor and then start the calibration by pressing [Y/+]. You can abort the procedure anytime by pressing [MODE].

10.4. Span Calibration

This procedure determines the second point of the sensor calibration curve for the sensor.

Note: When a manual calibration is performed, the readings shown are in the equivalent units of the calibration gas, and not the measurement gas.

10.4.1. QRAE 3 Pumped Model

The QRAE 3 pump draws at a flow rate of between 200cc/min and 450cc/min. The instrument must be connected to a cylinder of calibration gas with supplied tubing featuring a T calibration tube (P/N M02-3008-000), as illustrated below.

Note: A constant-flow regulator with flow rates from 500cc/min to 1000cc/min should be used.

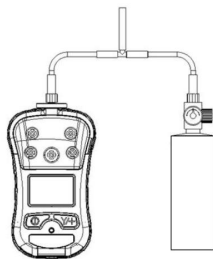

Note: Make sure pressure in the calibration gas cylinder is higher than 100 psi when using a T calibration tube.

QRAE 3 User's Guide

10.4.2. QRAE 3 Diffusion Model

Because there is no single inlet on the diffusion (non-pumped) version of the QRAE 3, a Calibration Adapter (calibration cap for diffusion models: P/N M02-3009-000; calibration tube for diffusion models: P/N M03-3010-000) is used for supplying calibration gas to all sensors at one time. Follow these steps for attaching the Calibration Adapter:



1. Align the Calibration Adapter's main body with the indented area around the QRAE 3's gas inlets.
2. Turn the knob clockwise to secure the Calibration Adapter to the instrument.
3. Connect the hose to the Calibration Adapter and to its gas source.
4. Make sure the Calibration Adapter is securely attached before starting the flow of calibration gas. (The Calibration Adapter has small grooves on its underside to allow gas to escape after passing over the sensors.)

QRAE 3 User's Guide

10.4.3 Multi-Sensor Span Calibration

This lets you perform a span calibration on multiple sensors simultaneously. It requires using the appropriate span gas and that the concentration labeled on the gas cylinder matches the concentration programmed in the QRAE 3.

1. Start the flow of calibration gas.
2. Attach the calibration adapter and gas to the QRAE 3.
3. Press [Y/+] to begin calibration. A countdown screen is shown. You can abort the calibration at any time during the countdown by pressing [MODE].

If the calibration reaches its conclusion, it shows the sensor names and tells you whether the calibration passed or failed, followed by the sensor readings.

10.4.4. Single-Sensor Span Calibration

To perform span calibration of an individual sensor, follow these steps:

1. At the Calibration Menu, select "Single Sensor Span."
2. Select a sensor from the list.
3. Start the flow of calibration gas.
4. Connect the calibration adapter and connect it to a source of calibration gas.
5. Verify that the displayed calibration value meets the concentration label on the gas cylinder.
6. Press [Y/+] to start calibrating. You can abort the calibration at any time during the countdown by pressing [MODE].

After a timer countdown, the span calibration is done. The LCD will display whether the calibration was successful and the reading for that calibration gas.

Note: If the sensor calibration fails, try again. If calibration fails again, turn off the power and then replace the sensor.

WARNING: Do not replace sensors in hazardous locations

11. Datalog Transfer, Monitor Configuration, and Firmware Upgrades Via Computer

Datalogs can be downloaded from the QRAE 3 to a computer, and firmware updates can be uploaded to the QRAE 3 via the USB port on the Travel Charger. Use the included Mini B USB (5-pin)-to-USB cable to connect the Travel Charger to a computer running ProRAE Studio II (version 1.7.0 or higher).

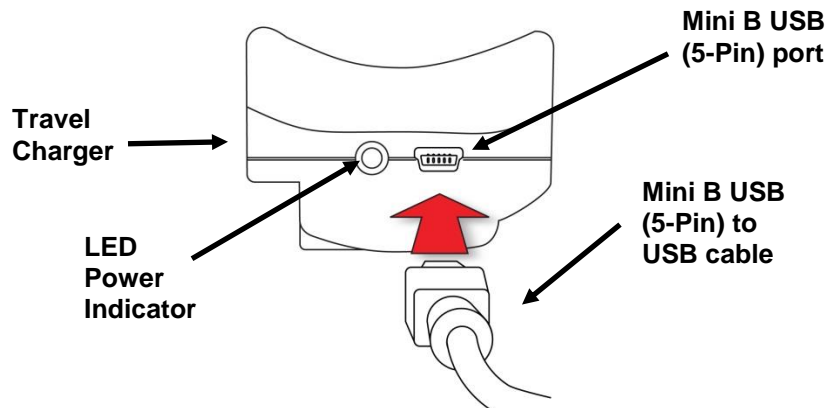

11.1. Downloading Datalogs And Performing PC-Based Instrument Configuration and Firmware Upgrades

The QRAE 3 communicates with a PC running ProRAE Studio II Instrument Configuration and Data Management software to download datalogs, configure the instrument, or upload new firmware.

The QRAE 3 must be connected to a PC through the supplied Travel Charger and must be in the PC communications mode.

1. Use the supplied PC Communications Cable (USB to mini-USB cable) to connect the Travel Charger to a PC.
2. Turn on the QRAE 3. Make sure it is running (with the main measurement screen showing).
3. Activate the PC communications mode on the QRAE 3 by pressing [MODE] repeatedly, starting from the main measurement screen until you reach the “Enter Communications Mode?” screen.
4. Press [Y/+]. Measurement and datalogging stop, and the instrument is now ready to communicate with the PC. The display now says “Ready To Communicate With PC Or AutoRAE2.”
5. Start up the ProRAE Studio II software, enter a password, and detect the instrument following the directions provided in the ProRAE Studio II User's Manual.
6. Follow the instructions in the ProRAE Studio II User's Manual to download the datalog, configure the instrument settings, or update the QRAE 3's firmware.
7. When you are done, press [MODE] to exit the PC communications mode on the QRAE 3. After upgrading the QRAE 3's firmware, the instruments will turn off automatically.

12. Maintenance

The QRAE 3 requires little maintenance, aside from replacing sensors, the filter, and the battery. If the instrument is equipped with a pump, it may need replacement, as well.

12.1. Replacing The Filters

Pumped Version

If the external filter is dirty or clogged, remove it by unscrewing it from the inlet. Discard it and replace it with a new filter.

IMPORTANT! A pumped QRAE 3 must not be calibrated or operated without a filter. Operation without a filter may damage the instrument.



12.2. Removing/Cleaning/Replacing Sensor Modules

WARNING! Do not replace sensors in hazardous locations.

All sensors are located inside the sensor compartment in the upper half of the QRAE 3. They are accessed by removing the four screws in the top portion and then turning the instrument over and lifting off the sensor cover.

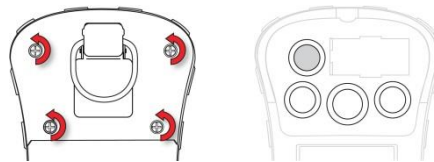

1. Turn off the instrument.
2. Remove the four screws holding the sensor compartment.
3. Turn over the instrument and remove the cover. The sensors are plugged into the slots.
4. Gently lift out the desired sensor module with your fingers.
5. Install the replacement sensor. Make sure the electrical contact pins are aligned with the holes in the PC board and that the sensor is seated firmly.
6. Replace the cover and tighten the four screws.

IMPORTANT! Always perform a full calibration after replacing sensors.

QRAE 3 User's Guide

12.3. Sensor Locations

IMPORTANT!

The current QRAE 3 model number is PGM-25XX ("D" indicates Diffusion). Sensors must be placed in the indicated sockets. A diffusion ("D") instrument cannot be changed to a pumped version, nor can a pumped version be converted to a diffusion version.

PGM-2500/D	Slot 1	Slot 2	Slot 3	Slot 4
LEL	X			
EC		X (Group P)		X (Group P)
OXY			X	

Group P: CO, H₂S, SO₂, HCN, NH₃, and PH₃

PGM-2560/D	Slot 1	Slot 2	Slot 3	Slot 4
LEL	X			
EC		X (Group N)		X (Group P)
OXY			X	

Group N: Cl₂, NO₂



IMPORTANT! Always calibrate the instrument after replacing or removing sensors.

QRAE 3 User's Guide

12.4. Changing The QRAE 3 Sensor Configuration

IMPORTANT!

The following table lists sensor slot allocations on the printed circuit board inside the QRAE 3. When changing sensors, be careful to make sure each sensor is in the correct slot and that the pins are not bent or incorrectly placed.

Sensor configuration:

Slot Model	Slot 1	Slot 2 (Group P)	Slot 3	Slot 4 (Group P)
Updated PGM-2500/D	3R LEL	3R H ₂ S (3 pins)	4R Liquid O ₂	3R CO (3 pins)
		3R CO (3 pins)		3R H ₂ S (3 pins)
		3R SO ₂		3R SO ₂
		3R HCN		3R HCN
		3R NH ₃		3R NH ₃
		3R PH ₃		3R PH ₃

Sensor configuration:

Slot Model	Slot 1	Slot 2 (Group N)	Slot 3	Slot 4 (Group P)
Updated PGM-2560/D	3R LEL	3R NO ₂	4R Liquid O ₂	3R CO
				3R H ₂ S
				3R SO ₂
		3R Cl ₂		3R HCN
				3R NH ₃
				3R PH ₃

Note: In order to support this procedure, your QRAE 3's current firmware must be V2.02 or above. ProRAE Studio II must be V1.9 or above.

QRAE 3 User's Guide

1. Connection:
 - a. Connect QRAE 3 unit to PC through the QRAE 3 Travel Charger.
 - b. Set the QRAE 3 into PC Communication mode.
 - c. Start ProRAE Studio II on the PC and go into Setup >> Sensor Maintenance to do the sensor configuration setting after placing new sensors in the QRAE 3.

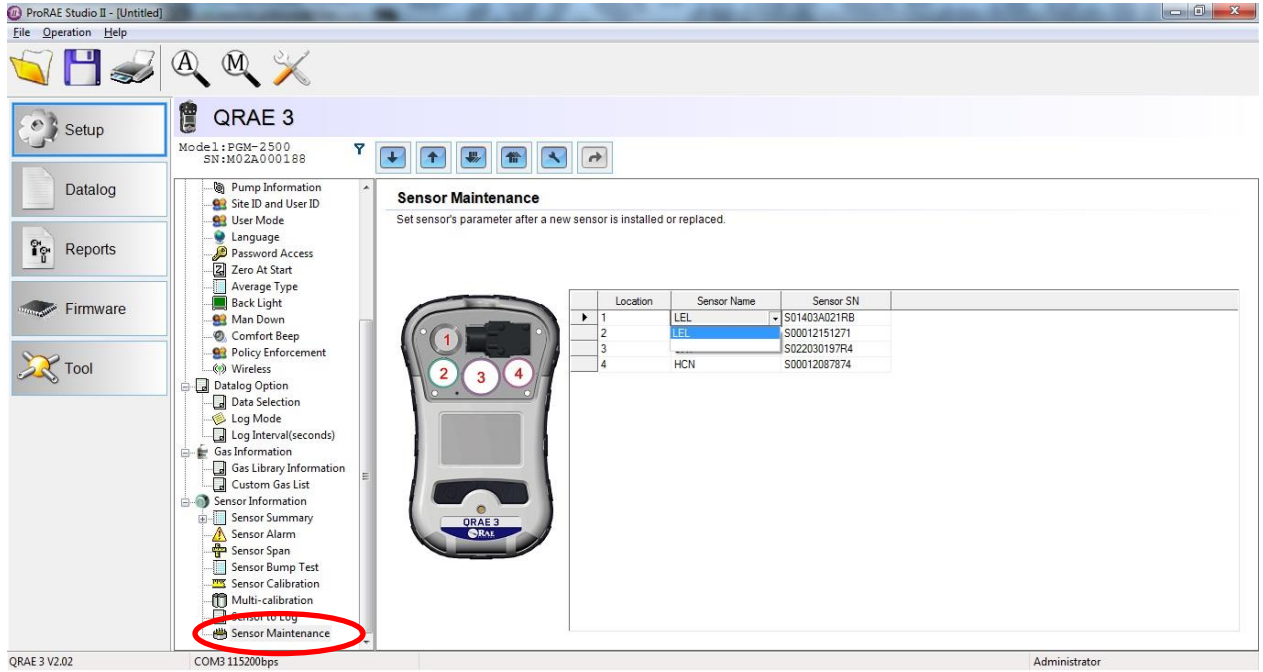

QRAE 3 User's Guide

- The locations of 3R LEL sensor & 4R Liquid O₂ sensor are fixed to Slot 1 & Slot 3. So after changing to a new sensor, you must change the sensor S/N (serial number) through ProRAE Studio II.

Important: You only need to input last 10 digits of the sensor S/N. It is not necessary to input "S0".

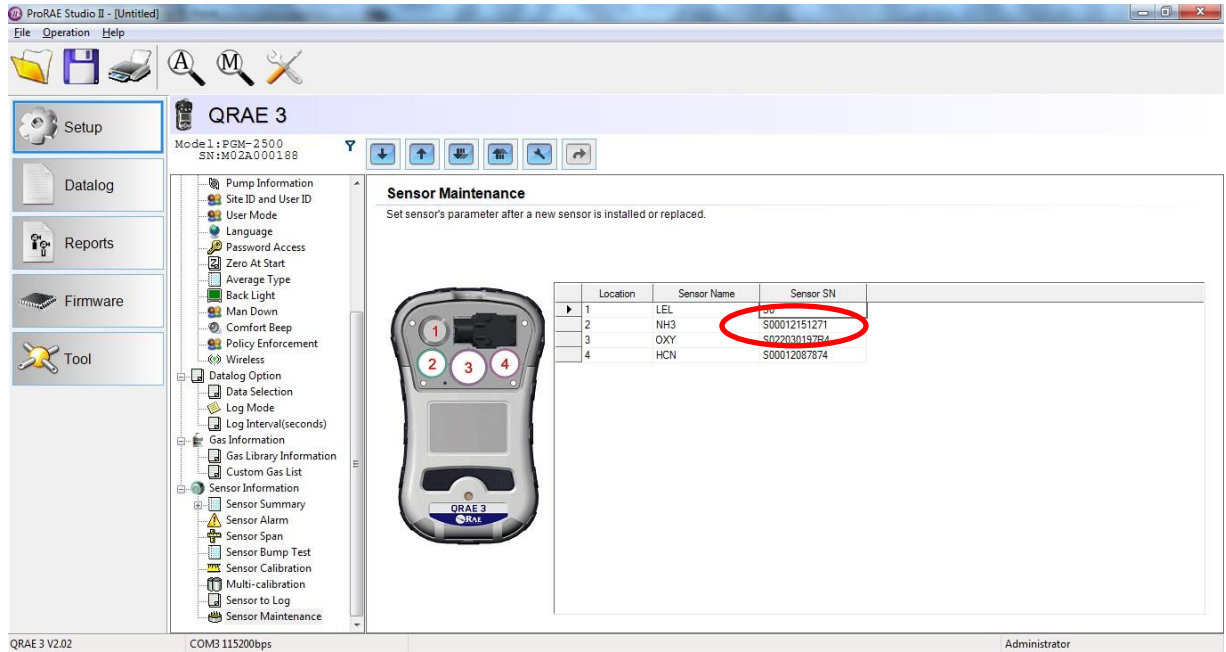

If you do not input all 10 digits of the sensor S/N, you will be alerted by red highlighting on the serial number text.

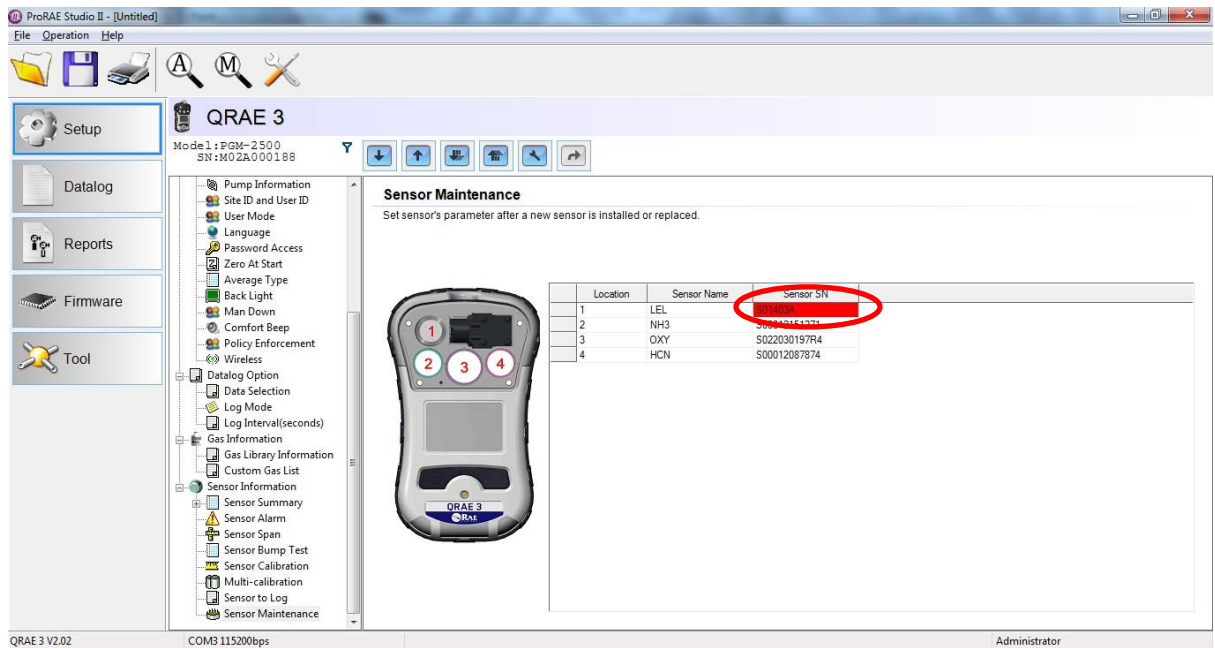

QRAE 3 User's Guide

- Slot 2 & Slot 4 accommodate 3R EC (electrochemical) sensors. These slots support Group P EC sensors in an updated PGM-2500/D. The drop-down list is used to set the sensor ID after installing a new sensor. You must also input last all 10 digits of the S/N for the new sensor.

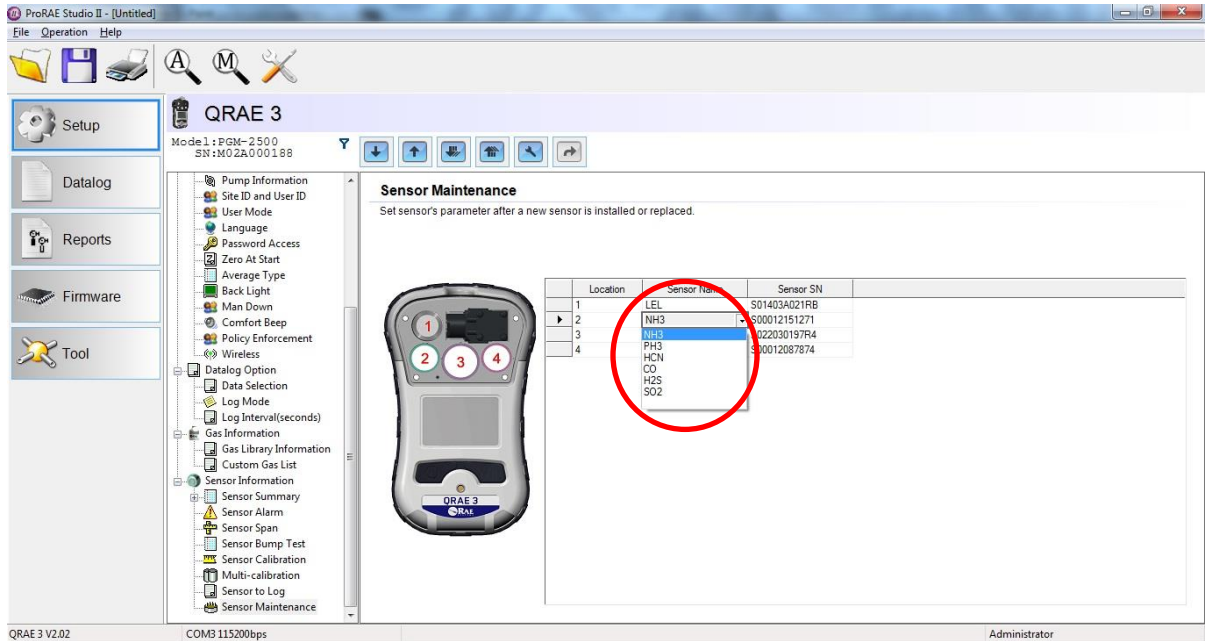

Note: For an updated PGM-2560/D, Slot 2 only supports Group N sensors, and not Group P sensors. Also, Slot 4 only supports Group P sensors.

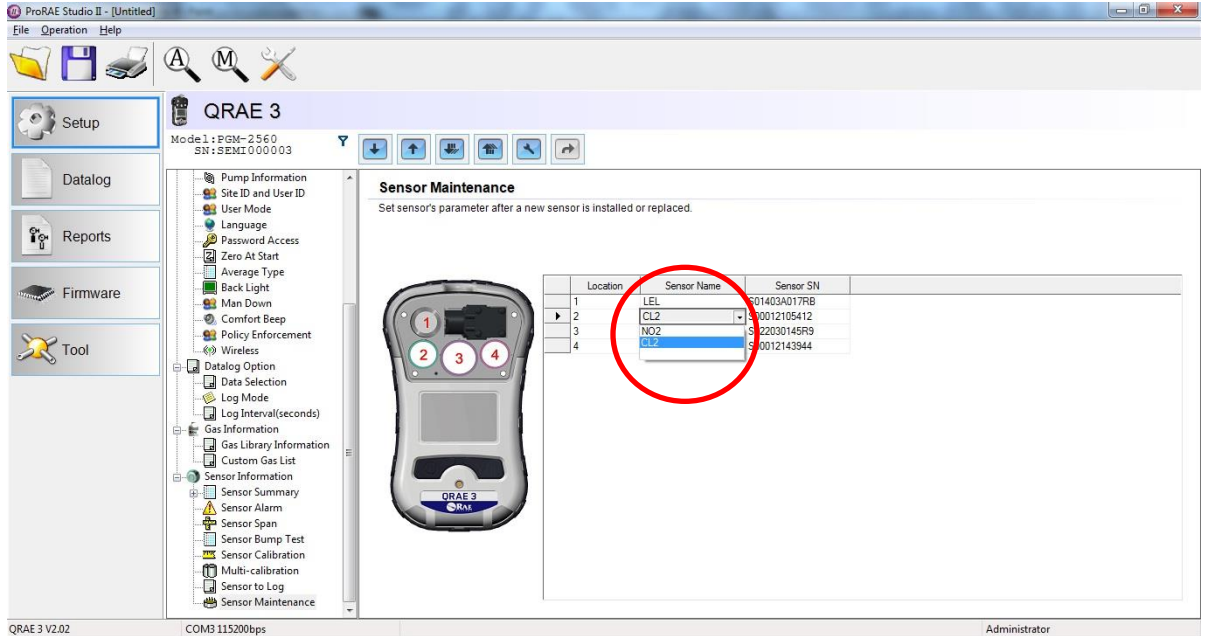

QRAE 3 User's Guide

4. After you have changed the parameter settings for all new sensors, you must upload the changes to the QRAE 3.
 - a. Press the “Set” to send current settings changes to the QRAE 3.

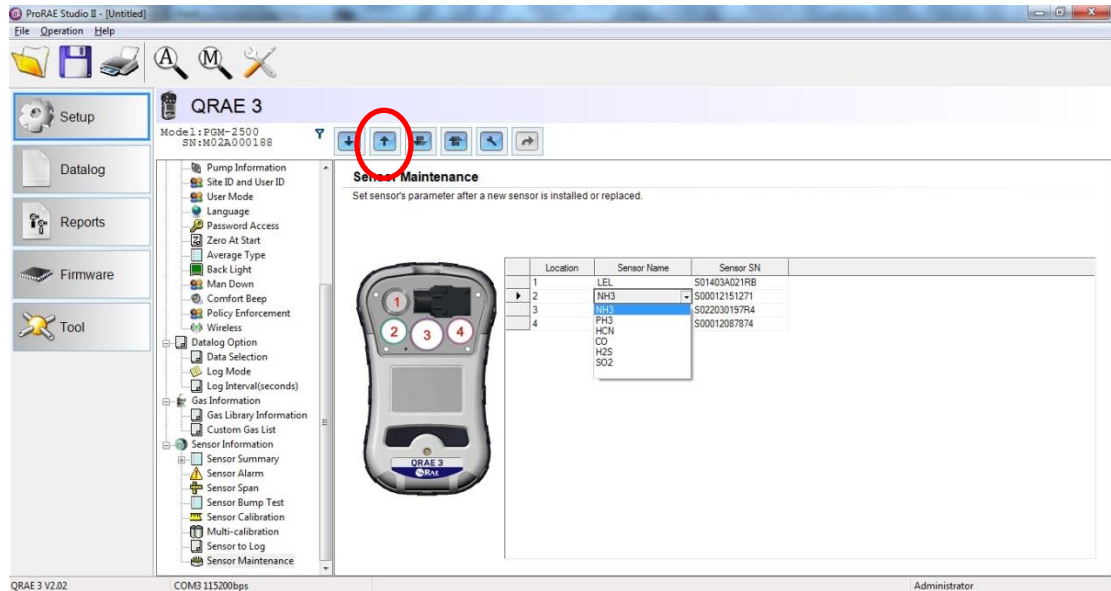

- b. You must click “OK” to confirm the changes:

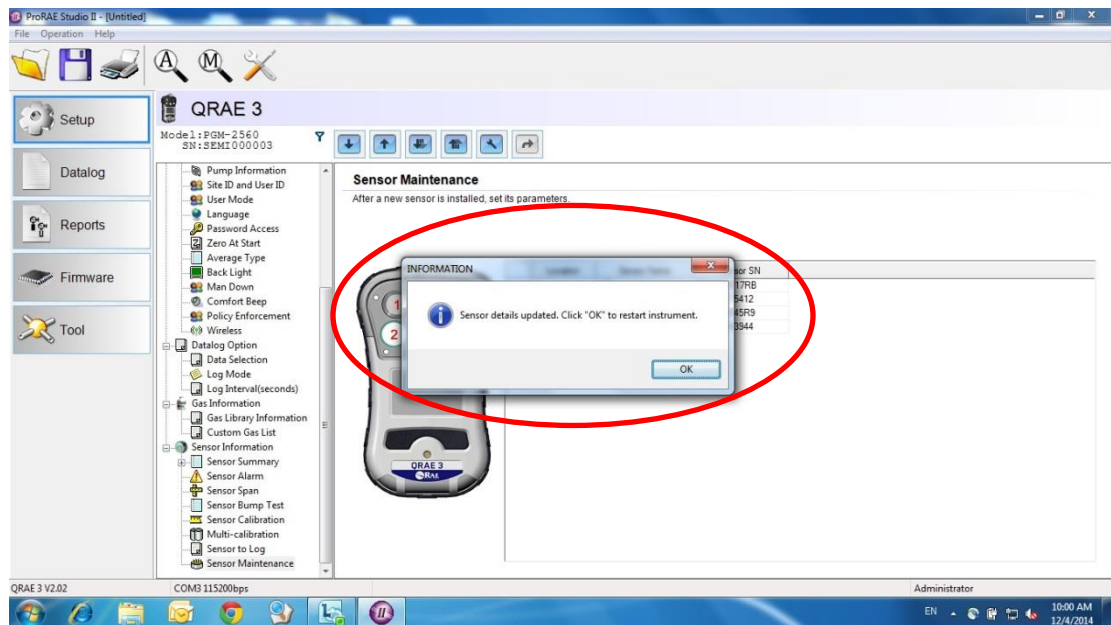

5. ProRAE Studio II sends an order to restart the QRAE 3, to confirm all firmware changes.
6. Turn on the QRAE 3 to make sure that unit is showing the correct sensor configuration.

IMPORTANT!

Before using the QRAE 3, you must calibrate all sensors in the QRAE 3 to ensure proper performance.

QRAE 3 User's Guide

12.5. Replacing The Pump

If your QRAE 3 has a pump and it requires replacement, follow these steps. Make sure the battery is removed before proceeding.

1. Remove the rear cover.
2. The pump is held in place by a metal bracket and two Philips screws. Remove the two screws.
3. Lift off the metal bracket.
4. The pump has an inlet and outlet that fit tightly over two small pipes inside the pump cavity. Pressing down on the instrument's body with one hand, pull the pump straight out.

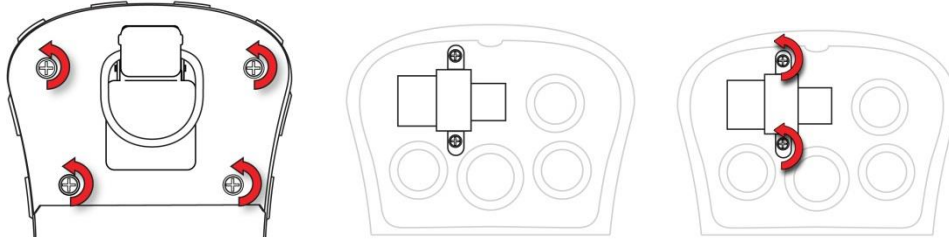

5. Press a new pump into place (a small amount of wiggling helps), making sure that both the inlet and outlet from the pump fit snugly over the two pipes.
6. Place the metal bracket over the pump.
7. Insert and tighten the two screws that attach the bracket to the housing.
8. Replace the cover.
9. Turn on the instrument and check for proper pump operation.

13. Alarms Overview

The QRAE 3 provides an unmistakable five-way alarm notification system that combines local alarms on the device with real-time remote wireless alarm notification to take worker safety to the next level. Local alarms include audible buzzer alarm, visible alarm via bright LED lights, vibration alarm, and an alarm notification on the display. These can be programmed or selectively turned on or off.

13.1. Alarm Signals

During each measurement period, the gas concentration is compared with the programmed alarm limits for Low, High, TWA and STEL alarm. If the concentration exceeds any of the preset limits, the alarms are activated immediately to warn both the QRAE 3 user and a remote safety officer (if wireless is enabled) of the alarm condition.

In addition, the QRAE 3 alarms if one of the following conditions occurs: battery voltage low, pump blocked, etc.

When the low battery alarm occurs, there may be approximately 10 minutes of operating time remaining. In this case, it is recommended that you promptly change or charge the battery in a non-hazardous location.

13.2. Changing The Alarm Mode

Your choices are Auto Reset and Latched. A latched alarm stays on until you acknowledge the alarm by pressing a key. An auto-reset alarm turns off when the condition that set off the alarm is no longer present (for instance, a high H₂S reading that exceeds the preset threshold and triggers an alarm, but then lowers below that threshold, turning the alarm off).

1. Enter the Alarm Mode sub-menu of the Alarms section under the Programming Menu.
2. Select Auto Reset or Latched by pressing [MODE] to select, and [Y/+] to confirm the choice.
3. Press [Y/+] to save your selection.

QRAE 3 User's Guide

13.3. Alarm Signal Summary

Alarm Summary

Alarm Type	Buzzer & LED	Display	Vibration	Reading	Backlight	Priority
Super Alarm	4 beeps/sec	“Man Down Alarm” screen	400ms	-	On	Highest
Man Down Alarm	3 beeps/sec	“Man Down Alarm” screen	400ms	-	On	
Man Down Warning	2 beeps/sec	“Are You OK?” screen	400ms	-	On	
Pump	3 beeps/sec	Blinking pump symbol	400ms	Reading	On	
Max	3 beeps/sec	“Max” at sensor location	400ms	Blinking reading	On	
Over Range	3 beeps/sec	“Over” at sensor location	400ms	Blinking maximum reading	On	
High	3 beeps/sec	“High” at sensor location	400ms	Blinking reading		
Low	3 beeps/sec	“Low” at sensor location	400ms	Blinking reading		
Negative	1 beep/sec	“Neg” at sensor location	400ms	Blinking “0”	On	
STEL	1 beep/sec	“STEL” at sensor location	400ms	Blinking reading	On	
TWA	1 beep/sec	“TWA” at sensor location	400ms	Blinking reading	On	
Calibration Failure	1 beep/sec	“Cal” at sensor location	400ms	Blinking reading	On	
Bump Failure	1 beep/sec	“Bump” at sensor location	400ms	Blinking Reading	On	
Datalog Full	1 beep/sec	Blinking datalog symbol	400ms	Reading	On	
Calibration Due	-	“CAL” at sensor location	-	Blinking Reading	-	
Bump Test Due	-	“Bump” at sensor location	-	Blinking Reading	-	
Battery	1 beep/min	Blinking battery symbol	400ms	Reading	Stays as is	
Network Lost	1 beep/sec	Blinking radio symbol	400ms	Reading	On	
Network Joined	1 beep	Radio symbol	400ms	Reading	On	
Comfort Beep	1 beep/min No LED flash	-	-	Reading	-	Lowest

Notes

“Negative” means that the reading is below zero.

“Network Lost” means that the QRAE 3 has lost wireless connectivity with its network.

“Network Joined” means that the QRAE 3 has joined a wireless network.

QRAE 3 User's Guide

General Alarms

Message	Condition	Alarm Indications
HIGH	Gas exceeds "High Alarm" limit	3 beeps/flashes per second
OVR	Gas exceeds sensor's measurement range	3 beeps/flashes per second
MAX	Gas exceeds electronic circuit's maximum range	3 beeps/flashes per second
LOW	Gas exceeds "Low Alarm" limit*	2 beeps/flashes per second
TWA	Gas exceeds "TWA" limit	1 Beep/flash per second
STEL	Gas exceeds "STEL" limit	1 Beep/flash per second
Crossed pump icon flashes	Inlet blocked or pump failure	3 beeps/flashes per second
Empty battery icon flashes	Low battery	1 flash, 1 beep per minute
CAL	Calibration failed, or needs calibration	1 beep/flash per second
NEG	Zero gas reading measures less than number stored in calibration	1 beep/flash per second

* For oxygen, "low alarm limit" means a concentration is lower than the low alarm limit.

Testing Alarms

Under normal operation mode and non-alarm conditions, the audible, visible, and vibration alarms can be tested at any time by pressing the [Y/+] key.

14. Troubleshooting

Problem	Possible Reasons & Solutions
Cannot turn on power after charging the battery	<p>Reasons: Defective charging circuit. Defective battery.</p> <p>Solutions: Replace battery or charger. Try charging the battery again.</p>
Lost password	<p>Solutions: Call Technical Support at +1 408-952-8461 or toll-free at +1 888-723-4800</p>
Buzzer, LED lights, and vibration motor inoperative	<p>Reasons: Buzzer and/or other alarms disabled. Bad buzzer.</p> <p>Solutions: Check under “Alarm Settings” in Programming Mode that buzzer and/or other alarms are not turned off. Call authorized service center.</p>
Pump failed message. Pump alarm.	<p>Reasons: Inlet probe blocked. Direct connection to a gas outlet while the gas value is turned off. External filter sucks in water. External filter too dirty. Water condensed along the inlet probe. Bad pump or pump circuit.</p> <p>Solutions: Remove the blocking objects and then press [Y/+] key to reset the pump alarm. Replace contaminated external filter. Be careful not to allow water condensation inside the unit. Replace the pump.</p>

If you need replacement parts, please contact an authorized RAE Systems distributor.

15. Diagnostic Mode

In Diagnostic Mode, the QRAE 3 provides raw counts for sensor, battery, and other readings, as well as a list of installed sensors and information about them (expiration date, serial number, etc.). Most of these screens are useful only to service technicians. A few allow access for changing settings.

The QRAE 3's Diagnostic Mode can only be accessed at startup time. In Diagnostic Mode, QRAE 3 displays readings in raw counts instead of units such as parts per million (ppm).

15.1. Entering Diagnostic Mode

1. With the QRAE 3 turned off, press and hold both [MODE] and [Y/+].
2. When the display turns on and the password screen appears, release the keys.
3. Enter the 4-digit password (the password is the same as the one for the Programming Mode; the default password is 0000).
 - Step from one position in the four-character string to the other by pressing [MODE].
 - Press [Y/+] repeatedly to select a desired number. Numbers increase from 0 to 9.
 - Once 9 is reached, pressing [Y/+] again “wraps” around back to 0.

QRAE 3 User's Guide

4. When you are done, press [MODE] followed by [Y/+]. If you input the correct password, you see the "Product Model" screen.

15.2. Exiting Diagnostic Mode

1. Turn off the QRAE 3 by pressing and holding [MODE]. There will be a standard shutoff countdown.
2. When the instrument shuts off, you will be alerted. Release your finger.

Note: The next time you start QRAE 3, hold only [MODE], and it will automatically start in Normal Mode.

15.3. Navigating Diagnostic Mode

Step through Diagnostic Mode by pressing [MODE]. The first screen you see is information about the product, including the serial number, firmware version, etc.

Press [MODE] to advance through the screens:

- Instrument model name, serial number, and ID
- Instrument Firmware
- Sensors Installed
- Socket 1
- Socket 2
- Socket 3
- Socket 4
- Socket Raw Count
- Zero/Span Count
- Location 1 ID and Name
- Location 2 ID and Name
- Location 3 ID and Name
- Location 4 ID and Name
- Buzzer Mode
- Buzzer Frequency
- Pump (High)
- Pump (Low)
- Battery
- RTC (real-time clock)
- Lights/Vibrator
- Temperature
- LCD Contrast
- LCD Test
- Position Sensor
- Run Time
- Communication – Enter communication mode with computer (Datalogging And Measurement Will Pause)

QRAE 3 User's Guide

16. Specifications

Instrument Specifications

Size	Diffusion: 5.5" x 3.2" x 1.5" (140 mm x 82 mm x 42 mm) Pumped: 5.7" x 3.2" x 1.7" (145 mm x 82 mm x 42 mm)
Weight	Diffusion: 12.9 oz (365 g with Li-ion battery and clip) Pumped: 14.5 oz (410 g with Li-ion battery, clip, and external filter)
Sensors	Four field-replaceable sensors, including electrochemicals for toxics and oxygen, combustible LEL
Battery Options	<ul style="list-style-type: none"> • Rechargeable Li-ion: 14 hours continuous without wireless and no alarms, in diffusion mode; 11 hours continuous without wireless and no alarm in pumped mode; 10 hours with wireless and no alarm in diffusion mode; 8 hours continuous with wireless and no alarm in pumped model <p>Note: All battery specifications at 20° C; lower temperatures will affect runtime.</p>
Display	<ul style="list-style-type: none"> • Monochrome graphic display (128 x 80) • Display size: 40 mm x 27 mm with backlighting (activated automatically in dim ambient lighting conditions, when monitor is in alarm, or with a key press) • Automatic screen flipping.
Display Readout	<ul style="list-style-type: none"> • Real-time reading of gas concentrations; battery status; pump status (if equipped with pump); datalogging on/off; wireless on/off and wireless reception quality. • STEL, TWA, peak, and minimum values • Man Down and policy enforcement indicators
Keypad	2 operation and programming keys (MODE and Y/+)
Sampling	Built-in pump (200cc/min to 450cc/min) or diffusion. Can sample through tubing up to 30 meters long; using tubing increases response time
Calibration	Manual
Alarms	<ul style="list-style-type: none"> • Wireless remote alarm notification; multi-tone audible (95 dB @ 30 cm), vibration, visible (flashing bright red LEDs), and on-screen indication of alarm conditions • Man Down Alarm with pre-alarm and real-time remote wireless notification
Datalogging	<ul style="list-style-type: none"> • Continuous datalogging (three months for four sensors at 1-minute intervals, 24/7) • User-configurable datalogging interval (from 1 to 3,600 seconds)
Communication and Data Download	<ul style="list-style-type: none"> • Data download and instrument set-up and upgrades on PC via charging and Travel Charger • Wireless data and status transmission via built-in RF modem (optional)
Wireless Network	RAE Systems Dedicated Wireless Network and closed-loop systems (with EchoView Host)
Wireless Frequency	ISM license free band, 868Mhz or 900Mhz FCC Part15, CE R&TTE, ANATEL
Wireless Range (Typical)	EchoView Host & QRAE 3: Line of sight >200m (650 ft), receiving data >80% ProRAE Guardian & Mesh Reader & QRAE 3: Line of sight >200m (650 ft), receiving data >80% ProRAE Guardian & RAELink3 & QRAE 3: Line of sight >100m (330 ft), receiving data >80%

QRAE 3 User's Guide

Instrument Specifications	
<i>continued</i>	
EM Immunity	EMI and EDS test: 100MHz to 1GHz 30V/m, no alarm Contact: ±4kV, Air: ±8kV, no alarm
Operating Temperature	-4° to 122° F (-20° to 50° C)
Humidity	0% to 95% relative humidity (non-condensing)
IP Rating	Pumped: IP-65 Diffusion: IP-67
Hazardous Location Approvals	USA and Canada: classified for use in Class I, Division 1, Groups A, B, C and D Global: IECEx Europe: ATEX (II 1G Ex ia IIC T4)
CE Compliance (European Conformity)	2004/108/EC (EMC) 1999/5/EC (Radio) 94/9/EC (ATEX)
FCC Compliance	FCC Part 15
Languages	Arabic, Chinese, Czech, Dutch, English, French, German, Indonesian, Italian, Japanese, Korean, Norwegian, Polish, Portuguese, Russian, Spanish, Swedish, and Turkish (language must be changed through ProRAE Studio II)
Warranty	<ul style="list-style-type: none"> • Three years on LEL, CO, H₂S, and O₂ sensors • One year on other sensors

Specifications are subject to change.

Wireless Approval For UAE In Middle East

TRA REGISTERED No: ER36635/15

DEALER No: HONEYWELL INTERNATIONAL MIDDLE EAST - LTD - DUBAI
BR

Wireless Approval For QATAR In Middle East

ictQATAR

Type Approval Reg. No.: R-4635

QRAE 3 User's Guide

Sensor Specifications

Combustible Sensor	Range	Resolution
Catalytic bead LEL	0 to 100% LEL	1% LEL
Electrochemical Sensors	Range	Resolution
Carbon Monoxide (CO)	0 to 500 ppm	1 ppm
Hydrogen Cyanide (HCN – 4R Sensor)	0 to 50 ppm	0.5 ppm
Hydrogen Cyanide (HCN – 3R Sensor)	0 to 50 ppm	0.2 ppm
Hydrogen Sulfide (H ₂ S)	0 to 100 ppm	0.1 ppm
Sulfur Dioxide (SO ₂)	0 to 20 ppm	0.1 ppm
Oxygen (O ₂)*	0 to 30% Vol.	0.1% Vol.
Ammonia (NH ₃)	0 to 100 ppm	1 ppm
Phosphine (PH ₃)	0 to 20 ppm	0.01 ppm
Chlorine (Cl ₂)	0 to 50 ppm	0.05 ppm
Nitrogen Dioxide (NO ₂)	0 to 50 ppm	0.1 ppm

* Only use the liquid electrolyte O₂ sensor in the QRAE 3. Use of other types can degrade performance.

All specifications are subject to change without notice.

LEL Range, Resolution & Response Time

LEL 0-100% 1 % 15 sec

Caution:

Refer to RAE Systems Technical Note TN-144 for LEL sensor poisoning.

QRAE 3 User's Guide

Year Of Manufacture

To identify the year of manufacture, refer to the serial number of the instrument.

The second to last digit in the serial number indicates the year of manufacture. For example, "M" indicates the manufacturing year is 2010.

First digit	Year
J	2008
K	2009
M	2010
N	2011
P	2012
Q	2013
R	2014
S	2015
T	2016
U	2017
V	2018
W	2019

Standard Span Values For Sensors

Sensor	Standard Span Values
CO	50 ppm
H ₂ S	10 ppm
OXY	18.0 %
LEL	50 %LEL Methane
SO ₂	5 ppm
HCN (3R sensor and 4R sensor)	10 ppm
NH ₃	50 ppm
PH ₃	5 ppm
Cl ₂	10 ppm
NO ₂	5 ppm

17. Controlled Part of the Manual for PGM-25XX/D

SAFETY INSTRUCTIONS

Read Before Operating

This Manual must be carefully read by all individuals who have or will have the responsibility of using, maintaining, or servicing this product. The product will perform as designed only if it is used, maintained, and serviced in accordance with the manufacturer's instructions. The user should understand how to set the correct parameters and interpret the obtained results.

CAUTION!

- Only use RAE Systems battery pack P/N G02-3004-000 (Li-ion, rechargeable)
- Charge the instrument Li-ion battery using the appropriate RAE Systems charger and only outside hazardous areas
- Use of non-RAE Systems components will void the warranty and can compromise the safe performance of this product
- Warning: Substitution of components may impair intrinsic safety

SPECIAL CONDITIONS FOR SAFE USE

- The PGM-25XX/D multi-gas detector must be calibrated if it does not pass a bump test, when a new sensor has been installed, or at least once every 180 days, depending on use and sensor exposure to poisons and contaminants
- No precautions against electrostatic discharge are necessary for portable equipment that has an enclosure made of plastic, metal or a combination of the two, except where a significant static-generating mechanism has been identified. Activities such as placing the item on a belt, operating a keypad or cleaning with a damp cloth, do not present a significant electrostatic risk. However, where a static-generating mechanism is identified, such as repeated brushing against clothing, then suitable precautions shall be taken, e.g., the use of anti-static footwear.

Note: Users are recommended to refer to ISA-RP12.13, Part II-1987 for general information on installation, operation, and maintenance of combustible gas detection instruments.

QRAE 3 User's Guide

WARNINGS:

ONLY THE COMBUSTIBLE GAS DETECTION PORTION OF THIS INSTRUMENT HAS BEEN ASSESSED FOR PERFORMANCE.

UNIQUEMENT, LA PORTION POUR DÉTECTOR LES GAZ COMBUSTIBLES DE CET INSTRUMENT A ÉTÉ ÉVALUÉE.

CAUTION: BEFORE EACH DAY'S USAGE, SENSITIVITY OF THE COMBUSTIBLE GAS SENSOR MUST BE TESTED ON A KNOWN CONCENTRATION OF METHANE GAS EQUIVALENT TO 20 TO 50% OF FULL-SCALE CONCENTRATION. ACCURACY MUST BE WITHIN 0 AND +20% OF ACTUAL. ACCURACY MAY BE CORRECTED BY CALIBRATION PROCEDURE.

ATTENTION: AVANT CHAQUE UTILISATION JOURNALIERE VERIFIER LA SENSIBILITE AVEC UNE CONCENTRATION CONNUE DE METHANE EQUIVALENTE A 20-50% DE LA PLEINE ECHELLE. LA PRECISION DOIT ETRE COMPRISE ENTRE 0-20% DE LA VALEUR VRAIE ET PEUT ETRE CORRIGEE PAR UNE PROCEDURE D'ETALONNAGE.

CAUTION: HIGH OFF-SCALE READINGS MAY INDICATE AN EXPLOSIVE CONCENTRATION.

ATTENTION: DES LECTURES SUPÉRIEURES A L'ÉCHELLE PEUVENT INDICER DES CONCENTRATIONS EXPLOSIVES.

QRAE 3 User's Guide



PGM-25XX/D Marking

The QRAE 3 (PGM-25XX/D) is certified by IECEx, ATEX and CSA for US and Canada as intrinsically safe.

The PGM-25XX/D is certified by IECEx, ATEX and CSA for US and Canada as intrinsically safe.

The PGM-25XX/D contains the following marking:

RAE SYSTEMS
 3775 N. 1st. St., San Jose
 CA 95134, USA
 PGM-25XX/D
 Type PGM-25XX/ PGM-25XXD
 Serial No/barcode: XXXX-XXXX-XX

IECEx CSA 13.0029X Ex ia IIC T4 Ga	 0575  II 1G SIRA 13 ATEX 2390X Ex ia IIC T4 Ga	 12.2583152 Cl.I, Div 1, Grps A,B,C,D T4. Class I, Zone 0 AEX/Ex ia IIC T4 C22.2 No.152-M1984 ANSI/ISA-12.13.01-2000 Intrinsically safe/ Securite Intrinseque/Exia
---------------------------------------	---	--

Ambient temperature: $-20^{\circ}\text{C} \leq T_{\text{amb}} \leq +50^{\circ}\text{C}$
 Um: 20V
 Battery Packs: G02-3004-000 (Li-ion rechargeable)

Warning:

- Read User's Manual for intrinsic safety precautions
- Read and understand Manual before operating

QRAE 3 User's Guide

Operation Area and Conditions

Hazardous Areas Classified by Zones

PGM-25XX/D is intended to be used in hazardous areas classified Zone 0, Zone 1 or Zone 2, within the T4 temperature code range, where gases of explosion groups IIA, IIB or IIC may be present.

For North America and Canada, the equipment can further be used in Class I, Zone 0 in the same T4 temperature range .

Hazardous Areas Classified by Divisions

PGM-25XX/D is intended to be used in hazardous areas classified for Class I, Div. 1 or 2, within the temperature range of -20° C to +50° C, where gases of explosion groups A, B, C or D may be present and within the T4 temperature code range.

Using the PGM-25XX/D in Class I, Division 1, Group A, B, C, D Hazardous Locations

Equipment which is intended for use in explosive atmospheres and which has been assessed and certified according to international regulations may be used only under specified conditions.

The components may not be modified in any way. The appropriate regulations for service and repair must be properly observed during such activities.

The PGM-25XX/D is intrinsically safe and may be used in hazardous locations.

SUBSTITUTION OF COMPONENTS MAY IMPAIR INTRINSIC SAFETY.

WARNING

TO REDUCE THE RISK OF IGNITION OF HAZARDOUS ATMOSPHERES, RECHARGE, REMOVE OR REPLACE THE BATTERY ONLY IN AN AREA KNOWN TO BE NON-HAZARDOUS! DO NOT MIX OLD AND NEW BATTERIES OR BATTERIES FROM DIFFERENT MANUFACTURERS.

QRAE 3 User's Guide

Year of Manufacture

To identify the year of manufacture, refer to the serial number of the instrument. The letter in the serial number indicates the year of manufacture. For example, "P" indicates the manufacturing year is 2012. Other alphabetical letters may be used after 2019.

Letter	Year
N	2011
P	2012
Q	2013
R	2014
S	2015
T	2016
U	2017
V	2018
W	2019

Combustible (LEL) Sensor Performance Specifications

Range

0 to 100% LEL

Resolution

1%

Response Time:

$T_{90} < 30$ sec.

Caution:

- Refer to RAE Systems Technical Note TN-114 for LEL sensor cross-sensitivities.
- Refer to RAE Systems Technical Note TN-144 for LEL sensor poisoning.

QRAE 3 User's Guide

Turning the PGM-25XX/D On

With the instrument turned off, press and hold the [MODE] key for 3 seconds, and then release. The startup process begins. The instrument performs a set of self-tests, while displaying information about instrument's settings, configuration, due dates for calibration and bump tests, etc.

When the startup completes, the PGM-25XX/D displays its normal measurement screen with instantaneous readings and other information in a fashion similar to what is shown in the illustration below (depending on the sensors installed).

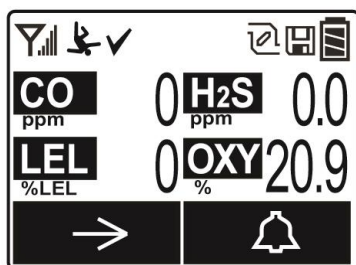

Turning the PGM-25XX/D Off

Press and hold [MODE]. A 5-second countdown to shutoff begins. You must hold your finger on the key for the entire shutoff process.

Alarm Signals

The instrument is equipped with audible, visible, and vibration alarms. During its normal operation, the PGM-25XX/D compares gas concentrations to the programmed alarm limits for Low, High, TWA and STEL alarms. If the concentration exceeds any of the preset limits, the loud buzzer, red flashing LED, and vibration alarm are activated immediately to warn of the alarm condition. In addition, the PGM-25XX/D alarms if the battery voltage is low, pump is blocked, etc.

When a low-battery alarm occurs, there may be approximately 20 to 30 minutes of operating time remaining. However, it is recommended that you promptly change or charge the battery in a non-hazardous location.

QRAE 3 User's Guide

Alarms Summary

Message	Condition	Alarm Indications
HIGH	Gas exceeds "High Alarm" limit	3 beeps/flashes per second
OVR	Gas exceeds sensor's measurement range	3 beeps/flashes per second
MAX	Gas exceeds electronic circuit's maximum range	3 beeps/flashes per second
LOW	Gas exceeds "Low Alarm" limit*	2 beeps/flashes per second
TWA	Gas exceeds "TWA" limit	1 Beep/flash per second
STEL	Gas exceeds "STEL" limit	1 Beep/flash per second
Crossed pump icon flashes	Inlet blocked or pump failure	3 beeps/flashes per second
Empty battery icon flashes	Low battery	1 flash, 1 beep per minute
CAL	Calibration failed, or needs calibration	1 beep/flash per second
NEG	Zero gas reading measures less than number stored in calibration	1 beep/flash per

* For oxygen, "low alarm limit" means a concentration is lower than the low alarm limit.

Testing Alarms

Under normal operation mode and non-alarm conditions, the audible, visual, and vibration alarms can be tested at any time by pressing the [Y/+] key.

QRAE 3 User's Guide

Programming Menu

Programming Menu is used to change instrument configuration settings can be entered from Normal Mode by pressing and holding [MODE] and [Y/+] together for more than 3 seconds and supplying a password when prompted.

Alarm Menus

Use these menus to change high, low, STEL, and TWA alarm limits -- the points at which alarms are triggered. It can also change alarm mode (latched or automatic reset) and alarm output methods (combinations of light, buzzer, and vibration alarm indications).

Changing Alarm Mode

Auto Reset and Latched alarm modes are supported. A latched alarm stays in alarm until the user acknowledges the alarm by pressing a key. An auto-reset alarm turns off when the condition that set off the alarm is no longer present. A user can configure the desired alarm mode by supplying a password and entering the Programming Menu / Alarms / Alarm Mode

Bump Testing and Calibration

RAE Systems recommends that a bump test be performed on the PGM-25XX/D prior to each use. A bump test is defined as a brief exposure of the monitor to the calibration gas to confirm that the sensors respond to gas and the alarms are functional and enabled.

The PGM-25XX/D multi-gas detector must be calibrated if it does not pass a bump test, when a new sensor has been installed, or at least once every 180 days, depending on use and sensor exposure to poisons and contaminants.

Calibration and bump test intervals are user-configurable to match national, regional, and local regulations.

All calibration and bump test options are available under Programming Menu/Calibration.

Calibration	
Single Bump	
Single Zero	
Single Span	
↓	Select

Each bump test or calibration option shows a countdown followed by sensor reading and pass/fail results.

QRAE 3 User's Guide

Pumped Models (PGM-25XX)

The PGM-25XX's internal pump has two speed settings: low or high. The pump draws at a flow rate of between 200cc/min and 450cc/min. The instrument must be connected to a cylinder of calibration gas with supplied tubing featuring a T calibration tube, as illustrated below.

Note: A constant-flow regulator with flow rates from 500cc/min to 1000cc/min should be used.

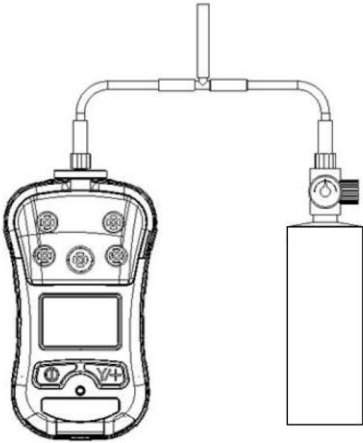

Diffusion Models (PGM-25XXD)

RAE Systems' provided calibration cap should be installed on the diffusion versions of the instrument when it is being bump tested or calibrated. A constant-flow regulator with flow rates from 500cc/min to 1000cc/min should be used.

WARNING: Make sure the calibration cap clips on and stays in the correct position during calibration, as illustrated below.

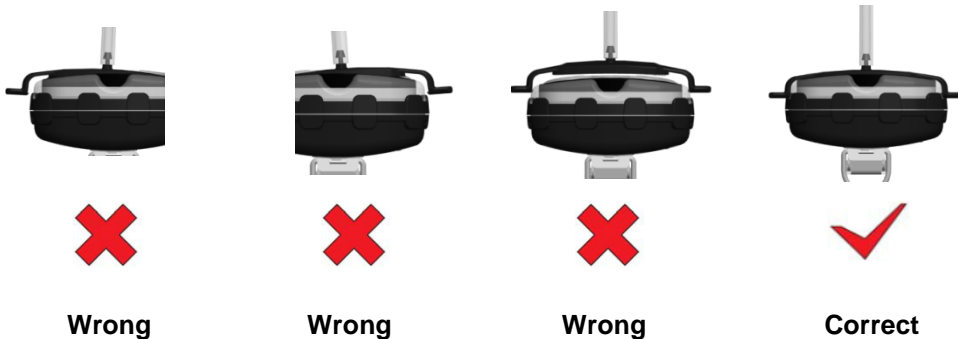

QRAE 3 User's Guide

Zero Calibration

The instrument should be zero calibrated in clean ambient air with 20.9% oxygen. A zero calibration should precede a span calibration.

Changing Span Value

Use this function to change the gas concentration to be used for bump testing or span calibration.

Note: If the sensor calibration fails, try again. If calibration fails repeatedly, the sensor(s) should be replaced. Replace the sensor.

WARNING: Do not replace sensors in hazardous locations.
--

Battery Replacement

A Li-ion battery pack (PN: G02-3004-000) is supplied with each PGM-25XX/D.

To replace a PGM-25XX/D battery pack, unscrew the two screws on the battery cover, and then remove the battery cover. After installing a new battery pack, reinstall the battery cover and the two screws.

QRAE 3 User's Guide

Troubleshooting

Problem	Possible Reasons & Solutions
Cannot turn on instrument after charging the battery	<p>Reason: Defective charging circuit. Defective battery.</p> <p>Solution: Replace battery pack or charger. Try another charger or battery.</p>
Lost password	<p>Solution: Call Technical Support at +1 408-952-8461 or toll-free at +1 888-723-4800</p>
Buzzer Inoperative	<p>Reason: Buzzer disabled. Bad buzzer.</p> <p>Solution: Check that buzzer is not turned off in Programming Menu. Call authorized service center.</p>
Pump failed message. Pump alarm.	<p>Reasons: Inlet probe blocked. Instrument directly connected to a gas outlet with the gas valve turned off. External filter sucked in water. External filter too dirty. Water condensed along the inlet probe. Bad pump or pump circuit.</p> <p>Solutions: Remove the blocking objects and then press [Y/+] key to reset the pump alarm. Replace contaminated external filter. Be careful not to allow water condensation inside the unit. Replace the pump.</p>

The list of replacement parts is available online at www.raesystems.com.

18. Technical Support

To contact RAE Systems Technical Support:

Monday through Friday, 7:00AM to 5:00PM Pacific (US) Time

Phone (toll-free): +1 877-723-2878

Phone: +1 408-952-8200

Fax: +1 408-952-8480

Email: RAE-tech@honeywell.com

Outside the Americas:

E-Mail: HAexpert@honeywell.com

Honeywell Analytics Ltd.

4 Stinsford Road

Nuffield Industrial Estate

Poole, Dorset, BH17 0RZ

United Kingdom

Tel: +44 (0) 1202 645 544

Fax: +44 (0) 1202 645 555

Honeywell Analytics

ZAC Athélia 4 – 375 avenue du Mistral

Bât B, Espace Mistral

13600 La Ciotat

France

Tel: +33 (0) 4 42 98 17 75

Fax: +33 (0) 4 42 71 97 05

Honeywell Analytics

Elsenheimerstrasse 43

80687 München

Germany

Tel: +49 89 791 92 20

Fax: +49 89 791 92 43

Honeywell Analytics

P.O. Box-45595

6th Street

Musaffah Industrial Area

Abu Dhabi

UAE

Tel: +971 2 554 6672

Fax: +971 2 554 6672

19. RAE Systems Contacts

RAE Systems by Honeywell World Headquarters

3775 N. First St.

San Jose, CA 95134-1708 USA

Phone: +1 888-723-4800

E-mail: RAE-tech@honeywell.com

Web Site: www.raesystems.com

Training

Phone: +1 408-952-8260

Email: training@raesystems.com

QRAE 3

User's Guide

CORPORATE HEADQUARTERS

RAE Systems by Honeywell

3775 North First Street

San Jose, CA 95134 USA

Phone: 408.952.8200

Fax: 408.952.8480

RAE-tech@honeywell.com

WORLDWIDE SALES OFFICES

USA/Canada 1.877.723.2878

Europe +800.333.222.44/+41.44.943.4380

Middle East +971.4.450.5852

China +86.10.5885.8788-3000

Asia Pacific +852.2669.0828